

# Recreational COMPUTING

VOL 7 NO 4 ISSUE 37 JANUARY - FEBRUARY 1979 \$2.00

FORMERLY  
**people's  
computers**

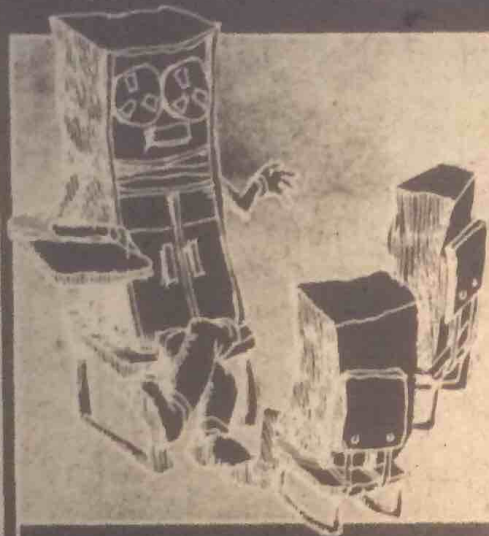

**A Fantasy  
Jules Verne**

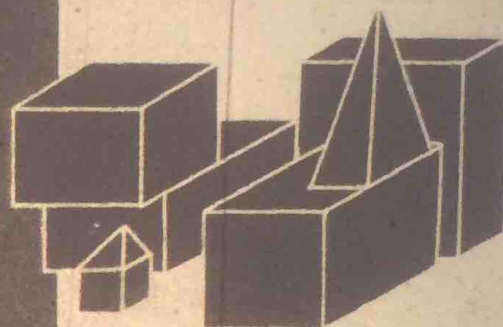

**Artificial  
Intelligence**



**The  
Apple Corps  
Is With Us**



**TRS-80:  
Personal  
Software**



## SUBMITTING ITEMS FOR PUBLICATION

**LABEL** everything please, your name, address and the *date*; tapes should also include the program name, language and system.

**TYPE** text if at all possible, double-spaced, on 8½ x 11 inch white paper.

**DRAWINGS** should be as clear and neat as possible in black ink on white paper.

**LISTINGS** are hard to reproduce clearly; so please note:

- Use a new ribbon on plain white paper when making a listing; we prefer roll paper or fan-fold paper.
- Send copies of one or more RUNs of your program, to verify that it runs and to provide a sense of how things work — and to motivate more of us to read the code. RUNs should illustrate the main purpose and operation of your program as clearly as possible. Bells, whistles and special features should just be described in the documentation unless they're particularly relevant.
- Make sure your code is well documented — use a separate sheet of paper. Refer to portions of code by line number or label or address please, not by page number. When writing documentation, keep in mind that readers will include beginners and people who may be relatively inexperienced with the language you're using. Helpful documentation/annotation can make your code useful to more people. Documentation should discuss just which cases are covered and which aren't.
- If you send us a program to publish, we reserve the right to annotate it (don't worry, we won't publish it if we don't like it).
- Last but not least, please try to limit the width of your listings: 50-60 characters is ideal. Narrow widths mean less reduction, better readability and better use of space.

**LETTERS** are always welcome; we assume it's OK to publish them unless you ask us not to. Upon request we will withhold your name from a published letter, but we will not publish correspondence sent to us anonymously. We reserve the right to edit letters for purposes of clarity and brevity.

**EXPIRATION DATE:** To decipher the expiration date of your subscription, look at the top right hand corner of your address label. The last two digits refer to a code/issue number that is your expiration date. Hence, read 35 as 9/78, 36 as 11/78, 37 as 1/79, 38 as 3/79, 39 as 5/79, 40 as 7/79, and so on.

## SUBSCRIPTION INFORMATION

### U. S. Subscriptions

- \$10/1 yr. (6 issues)
- Retaining subscription @ \$25 (\$15 tax deductible)
- Sustaining subscription @ \$100+ (\$90+ tax deductible)

Please allow 6-9 weeks for your first issue to arrive.

### International Rates

Payments must be in US Dollars drawn on a US bank.

- \$17 Canada First Class
- \$23 Rest of World Airmail
- \$14 World Surface Mail

Delivery of foreign mail is slow and unreliable. We strongly advise airmail.

These back issues are available at \$2.50 each:

- Vol 5, No 6
- Vol 6, Nos 1, 2, 3, 4, 5
- Vol 7, Nos 1, 2, 3

Foreign: add \$.50 per magazine.

### Foreign Distributors of *Recreational Computing*

Vincent Coen  
LP Enterprises  
313 Kingston Road  
Ilford IG1 1PJ  
Essex, UK

Rudi Hoess  
Electronic Concepts PTY Ltd  
Ground Floor Cambridge House  
52-58 Clarence St  
Sydney NSW 2000

ASCII Publishing  
305 HI TORIO  
5-6-7 Minami Aoyama  
Minato-Ku, Tokyo 107  
JAPAN

Eastern Canada  
Liz Janik  
RS-232  
186 Queen St W  
Suite 232  
Toronto ON M5V 1Z1

Western Canada  
Brian Wiebe  
Kitronic Audio, Digital &  
Electronic Components  
26236 26th Ave RR5  
Aldergrove  
BC VOX1A0  
Canada

Cover by Ann Miya

*Recreational Computing* (USPS 356870) is published bimonthly by People's Computer Company, 1263 El Camino Real, Box E, Menlo Park, CA 94025. People's Computer Company is a tax-exempt, independent, non-profit corporation, and donations are tax-deductible.

Second class postage paid at Menlo Park, California, and additional entry points.

Copyright © 1979 by People's Computer Company, Menlo Park, California

## STAFF

### EDITORS

Bob Albrecht

Lousie Burton

Ramon Zamora

### PRODUCTION MGR

Sara Werry

### PRODUCTION ASS'T

Carol Cullenbine

### ARTISTS

Aleeca Harrison

Ann Miya

Judith Wasserman

### TYPESETTERS

Phyllis Adams

Gavin Cullen

Renny Wiggins

### PROOFREADER

Nancy Heubach

### CIRCULATION

Michael Madaj

### BULK SALES

Cynthia Kosina

### SPOT EDITOR

Harry Saal

### PUBLISHER

Willard J. Holden

And a special thanks to all the other folks at People's Computer Co.: Claire Connor, Della Daniels, JoAnn Loeffler, Mary McLean, Ann Merchberger, Curtis Roads, Suzanne Rodriguez, John Strawn, Denise Winn, Nancy Wood.

## RETAINING SUBSCRIBERS

David R. Dick

Mark Elgin

John B. Fried

Scott B. Guthery

W.A. Kelley

Frank Otsuka

Shelter Institute

Brett Wilson

## SUSTAINING SUBSCRIBERS

Byte Publications

Paul, Lori and Tom Calhoun

Dick Heiser, The Computer Store

## ARTICLES

- 19 VENDING MACHINE GETS "BRAIN" by Pete Vansickel  
Yes, there *is* a free lunch
- 21 A NEW ALGORITHM FOR CHESS Part 1 By David Chelberg & David Watters  
When it won't fit, invent a new way
- 24 KEEPING TRACK OF 'MOTHER' by Ellen Levine  
Indexing becomes a cash crop in rural Oregon
- 42 APPLE II: EASY I/O SENSING AND CONTROL by Chuck Carpenter  
Turn the world on with your Apple

## SPECIAL FEATURES

- 8 ARTIFICIAL INTELLIGENCE by David Cudhea  
Cognology, cognomenclature and non-chimerical computers
- 20 ALICE IN COLLAPSAR-LAND by Warwick Slough  
And she fell up and up; she rose down and down
- 32 IN THE YEAR 2889 by Jules Verne  
SF master predicted computers, too
- 40 A DIFFERENT FORTRAN MAN SCENARIO by Sam Hills  
Revisionist reader sends our hero to the ropes
- 58 10 REM - ART REVIEW by Ramon M. Zamora  
Relief etchings based on computer data

## GAMES AND STUFF

- 15 TRS-80: THE MEMORY GAME by Ramon M. Zamora  
Test your short-term memory with this one
- 16 TRS-80: MILES PER GALLON PROGRAM by Milan D. Chepko  
Guaranteed for one year or 15,000 miles
- 26 BUILDING A HI-RES SHAPE TABLE FOR THE APPLE II  
by Carl Swenson  
Use a byte of your Apple to help you draw
- 29 AN ELECTRONIC DESK CALENDAR by Clyde Farréll  
Your TRS-80 can help you remember
- 39 RUNEQUEST by Steve Perrin and Friends  
Adventurers need only strength, charisma, intelligence and . . .
- 46 "REINO" - SPANISH KINGDOM by Todd Voros and Lee Schneider  
¿Donde esta *carriage return*?
- 52 TRS-80: CONCEPT GAME by Ramon M. Zamora  
A challenging multi-person game
- 54 SPOT: THE SOCIETY OF PET OWNERS AND TRAINERS by Harry Saal  
Pointers, products, peeves and paws

## DEPARTMENTS

- 4 EDITORS' NOTES AND LETTERS
- 14 PUBLISHER'S LETTER
- 48 DRAGONSMOKE
- 50 REVIEWS
- 59 ANNOUNCEMENTS



## Editors' Notes

A common friend of the editors once remarked that none of us *knows* what computers are really for. We all have our points of view. Some of us who work extensively with computers believe we have the answers. Others, unfamiliar with technology, predict doomsday worlds populated by highly rational and insensitive machines. Our friend is most likely right. None of us know the real answers. How computers will be used and what benefits/losses will accrue from their use is a set of questions that the future will answer.

That leaves each of us with our viewpoint; our way of looking at the world. And, as often happens, when the proper stimulus is applied, most of us are quick to volunteer what we believe. Changing the name of the magazine has provided such a stimulus. Several early responses are included in the LETTERS column this issue along with a cartoon representing an editorial comment on the hubbub being generated.

In the short space of this set of notes, it is impossible to provide a total perspective on our reasons for making the change. As a start though, we rely on the definition of the word *recreate*. To re-create is to restore; to refresh; to create anew. *Recreational* comes from a word that means to put fresh life into; to restore in both body and mind. Being recreational implies using diverting activities and play. Effort and work are not necessarily involved when you are *re-creating*. Also you can be learning, expanding and experiencing growth.

Bah!, come the replies. Yeah!, comes the support. And so it goes. We promise in future issues to continue this exploration of purpose and name change. Articles (yours and ours) dealing with the nature of games, simulations, the relationship of work and play and all that can evolve from these dialogues will be part of what *Recreational Computing* will become. Join us in this adventure! Write and let us know your point of view.

Dragon faces on the three-headed dragon (at least one face) have changed. Chuck Bradley now pursues his consulting activities full time. Louise Burton, a fugitive of the corporate publications world, takes his place. Louise didn't know anything useful about computers when she joined PCC, but thanks to her enthusiastic co-dragons, that's changing fast. Her only request to our contributors is that they stop addressing their letters "Dear Sirs."

—Ramon Zamora  
—Louise Burton  
—Bob Albrecht

# Letters

## OOPS! CONVICTED & EXECUTED... WITHOUT A TRIAL

What a Tragedy!!!

You are turning *People's Computers* into *Recreational Computing*. Instead of taking advantage of your 'big savings', I guess I will be forced to cancel my subscription, and salvage what is left of the money I paid for *People's Computers*.

The last thing I want is a magazine full of 'Recreational Computing.' More Wumpus, Star Trek and similar garbage for people to fritter away their time at?

We packed up the boob tube and shoved it in a closet because of the garbage on it which encourages people to fritter away their time. Now you want to pursue full-time frittering with computers??? And you call yourself a *People's Computer Company*??? You've got to be kidding.

I look for the computer to set us FREE. To manage our finances for our own benefit. To help us with our taxes; figure the best breaks on our income tax. Or setting up our own corporation. To balance the books of small businesses; encouraging small business, giving it the same breaks large business gets with big computers. To keep small groups and clubs going with computerized membership lists and mailings. To do worthwhile things.

Instead, you are proposing we play games with computers. What an abomination. What a shocking waste.

I guess we part company. Goodbye & regrets,

Q. Burke  
*Holtville Tribune*  
523 Pine Avenue  
Holtville, CA 92250

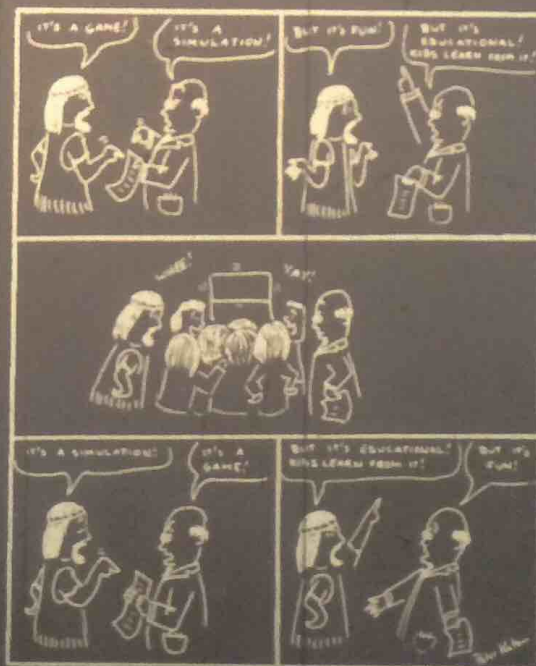

## LET'S HEAR IT FOR FUN AND GAMES!

Congratulations on the fine use of graphics in your TRS-80 programs which appeared in the November-December issue of *People's Computers*. Your staff is to be commended also for a fine typesetting job. I noted only one typographical error, and that was in line 206 of "Reverse".

Most of my work on the TRS-80 is business applications software, and I miss the recreational computing. Other publications are covering commercial applications of microcomputers, so it's good to know that your magazine will continue to provide education, fun, and games. I look forward to the publication of your book of TRS-80 games and programs.

Keep up the good work!

William S. Pitt  
Wm. S. Pitt & Associates  
P. O. Box GH  
Pacific Grove, CA 93950

## THE ROLE OF RECREATIONAL COMPUTING IN A HUMANIZING TECHNOLOGY

I believe that the most important role recreational computing can play in our highly technological society is to provide us with more effective ways of humanizing our manner of communication with one another. The tools which we create and utilize for communication are what really distinguish us as humans and these tools differentiate us from all other living species. There is no doubt that we are in an age of the microcomputer: an age when there is rarely any aspect of our daily lives not affected in some way by the invention of microprocessors and their utilization in the equipment and toys around us in our working and recreational environments. One example of this readily comes to mind: while I am not using a microprocessor-controlled typewriter to prepare the first draft of this letter, by the time the readers see what I have written in print, this draft will have gone through at least two separate microprocessor-controlled text-editing and typesetting systems. Microprocessors are the dominant integrated circuit in our electronics technology today. It is because we have this micro-

processor technology that we are living in a truly modern revolution, not unlike an earlier industrial revolution.

I think the question which faces us today as we stand at the brink of this new revolution in communication is this: how are we going to control our microprocessor technology so that it will not be used to dehumanize our future society or suffocate our present culture. So, the challenge that we face is this: how do we control the use of our microprocessor "tools" so that we do not dehumanize our communication systems—our society and our culture—which we have already created? Or, we can ask, how should we use computer technology to prevent cultural decay and societal dehumanization?

I believe the answer to this challenge is in the introduction of the personal computer in households all over our country. Actually I feel that people like Chuck Peddle, who engineered the design for the PET personal computer, and the Tandy Corporation, that planned the design for the TRS-80, have served this modern revolution of ours heroically by making personal computers available to the average consumer. There are thousands of PETs and TRS-80s which have been brought into households all over the world just in the last nine months. No doubt this trend will continue to skyrocket as we proceed into the 1980's.

If personal computers do prove to have revolutionary impact on our lives and the manner by which we communicate with one another in society, it will certainly be a dream come true for leaders of this revolution, like Chuck Peddle, who claimed early in the game that when personal computers found their way into the kitchens of America, housewives would soon be free to take on their new challenging role as "recreational programmers."

When this dream does become true, then we can say that the personal computing revolution and its offspring, recreational computing, has become an ideal humanizing foundation for our modern technology.

Randall Julin, Lab Manager &  
Information Systems Specialist,  
15 Poncetta Drive #322, Daly City,  
CA 94015



## SOME NEW USES FOR APPLE II (Or Alexander Portnoy Lives!)

It seems to me that your magazine has not paid enough attention to the Apple II. I have developed several articles which I will be happy to polish up and donate to your magazine if you will let me know which one or ones you want.

1. I have been unable to get the final bugs out of my program "PUNCH, VERSION 246.9234." I thought perhaps I was too close to it and therefore took time off to write "The Apple II as a Paperweight." This article, for your general readership, explores the gravitational capabilities of the Apple II. However, much of the material is probably adaptable to other microcomputer systems.

2. I have a draft of an article explaining my program "MOTHER." This program requires a modem interface with the Apple. The program calls you on the telephone and tells you what a rotten son you have been. An advanced digitized technique permits the Apple II to reproduce all those subtle voice inflections which provoked guilt when you were younger. Innuendo is rife. Testing of this program on a group of average neurotics has uniformly produced heartburn.

3. I am starting an article on my program "OUT OF THE CLOSET." This program checks the Apple hardware, much like a ROM tester, and determines your machine's sexual orientation. If your Apple does not have the correct preferences, the program modifies the machine's firmware so that it cannot be used for teaching. Documentation for this program will be contained in a disk textfile called "BRUCE."

Please advise.

Arthur Wells, Jr.  
428 Thirteenth Street.  
Oakland, CA

## CORRECTION: L-5 SOCIETY

Thanks for carrying the item "The L-5 Society" in *People's Computers*. However, I'm afraid we misled you in one respect. Regarding the "Future United States Space Program" in Houston last November, the prime organizing group was the American Astronautical Society; the L-5 Society only organized one session, "Social Aspects of Space."

Carolyn Henson, Pres.  
L-5 Society  
1620 N. Park  
Tucson, AZ 85719  
602/622-6351



## NEW READER'S REVIEW

Just saw my first issue of your magazine. Enclosed is my check for a one year subscription.

I have a PET so am interested in PET-related subjects and programs. It was very discouraging to learn that Commodore is one of the companies that ignores their customers.

I have had both FORTRAN and BASIC programming training but can make no sense at all out of "Snooping with your PET". My education is lacking something.

Tried the "Kingdom" program—worked with only two minor fixes. The command "RANDOMIZE" gets into syntax trouble, and the rats ate almost all of the grain every year. If no grain was planted, then line 910 would make more sense to print "THERE WAS NO HARVEST THIS YEAR" or some such thing. (I have lost in as few as five years and won in 25.)

I hope to see more good stuff from you, and may even send in a neat sorting-packing-alphabetical list-tape file program that I wrote.

John W. Davison  
Ft. Walton Beach, FL

Yes, *KINGDOM* does have a few problems, as we noted in our review of a new *KINGDOM* tape in the Nov.-Dec. issue (pp. 53-54). What's needed is a *KINGDOM II*. Let this be a challenge to all creative *KINGDOM* lovers!

## THE RETURN OF THE PHANTOM (WELCOME BACK!)

Hello, People!

I've been out of touch for a while—after all, it was my senior year, and all that! Anyhow, I am now comfortably ensconced here in Cambridge as a member of the class of 1982 of MIT. I'll probably major in computer science.

If you're interested in computers, MIT's facilities are hard to beat. There are PDP-8's and 11's in almost every lab. There's an IBM 370 with batch and TSO, a smaller batch system, used primarily to teach fortran, (oops, I mean FORTRAN), a PDP-11 UNIX system set aside solely for people taking an "Introduction to Computation" course, ARPANET stuff, Artificial Intelligence machines, and MULTICS. MULTICS (designed by MIT, I believe) runs on a Honeywell Series 6 Level 68. It's a huge, interactive time-shared system, capable of supporting over 85 simultaneous users!

I imagine there are micros around too (there've got to be), but they're probably in the individual labs. As of now, there is no course specifically about micros, but there will be one next term.

The really nice thing they have here is the SIPB ("Sip-Bee"), the Student Information Processing Board. It's primarily a bunch of computer hacks who know the systems around here inside-out. They

offer help and advice and (get this!) . . . money! If you want to learn a language, for example, go into their office, fill out an application, and 99% of the time they'll set up an account for you with some money credited. I told them I wanted to learn MULTICS and got \$50 worth of connect time.

Now for some bad news. In the process of moving up here, I lost a major section of my correspondence file—particularly the section where I kept most of the addresses. Therefore, friends, please write and send your address again. I promise to be more faithful about corresponding! I am especially interested in writing/corresponding about SF computer games, computer-based fantasy games, developing new languages, and micro implementations of current ones (anyone for tiny LISP?).

That last paragraph reminds me—I've seen printouts of a MULTICS game called 'ADVENTUR', which seems to be a fairly complete translation of *Dungeons and Dragons*.

I'll write again in a week or two, with a lot of comments about *People's Computers*.

Richard Salz ("The Phantom")  
Boston, MA

P.S.—I thought I forgot something—my address! 450 Beacon St., Boston, MA 02115. (Don't use "MIT". It fouls things up unbelievably!)

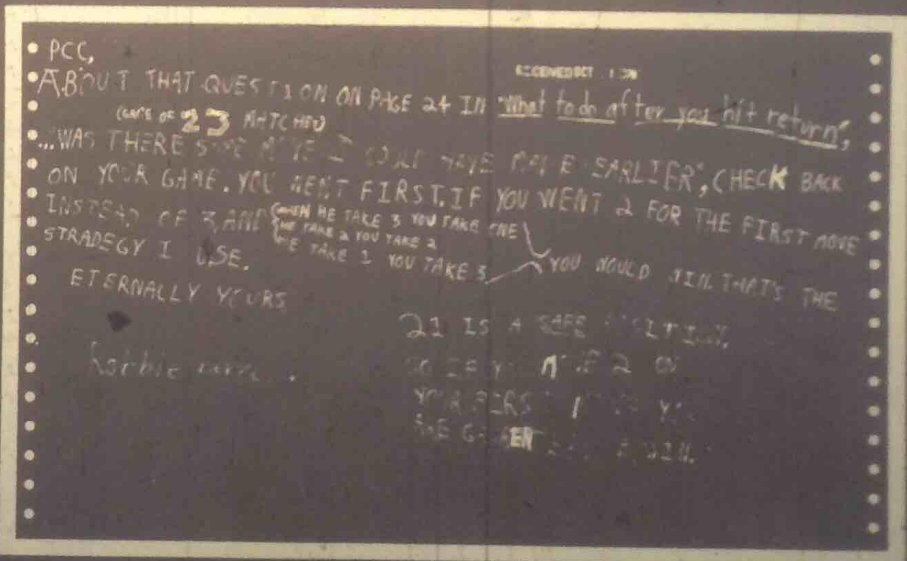

You got it, Robbie! Now suppose we start with 18 matches and you can take 1, 2 or 3 each turn. Can the first person always win? How about 17 matches— who can always win, first person or second person? — The Dragon

## OPTING FOR THE TRS-80

Although our school district has received much national attention through our Finger Calculation System, Chisanbop (a *real* People's Computer!), we have also recently launched ourselves into the microcomputer world.

Early this year we procured two Radio Shack TRS-80's for our Grimes Center for Creative Education (Grades 1-6).

We in the Northeast are a bit behind you Westerners in our progress with this fantastic revolution, but we're moving forward rapidly.

Our experience with Tandy's computer has, in fact, been totally favorable.

The PET was an option, of course, at the outset. After reading evaluations of both, and after having some hands on experience with both, we opted for the TRS-80. Our reasons were as follows:

1. The potential of the Z-80 chip
2. The U.L. approval
3. The possibility of using our own CRT's (that are widely prevalent in our schools) which would reduce our overall expense when project expansion occurs.
4. The expansibility of the unit's ROM to house an extended BASIC (comparable with PET's) would be utilized if and only if we reach that level of sophistication.

Thus far, we have trained both students (grades 4-6) and elementary school teachers in BASIC. Everyone is happy. Perhaps soon we will need the TRS's extended BASIC. For the time being, though, many of the Level I's limitations can be circumvented. For example:

1. The single dimension array on A can be partitioned to accommodate other "variables."
2. For two dimension array structures a simple formula allows for row skipping during variable assignment and/or recall.
3. Many string functions can be performed with non-string variable initialization.

In addition, the "logic" expansions of the IF-THEN with the Tiny BASIC's efficient line statement format and abbreviations made many of these alterations sit efficiently in memory.

Finally, we have adapted many of the standard game programs (as in "What To Do After You Hit Return?") in this tiny BASIC with little or no loss in sophistication.

In summation, if we, in fact, outgrow the TRS-80, we will probably upgrade the machine's BASIC and expand our present 8K RAM. We have been decidedly pleased with this reliable unit.

Seth Lachterman  
Supervisor of Mathematics and  
Evaluation  
Mount Vernon Public Schools  
Mount Vernon, NY 10553



## BREAKING TRAIL IN ALASKA WITH APPLE II

We are initiating a project utilizing 32K APPLE II computers with diskettes in 9 remote village locations in our school district. We would be extremely interested in any ideas or materials relating to computer assisted instruction for practically any subject for preschoolers through adult.

Please send us lists of educational software you have for sale or exchange as well as anything else you think might relate to our project.

Daniel Shanis  
Gifted and Computer-  
Assisted Instruction Coordinator  
Yukon-Koyukuk School District  
Nenana, Alaska 99760

*We don't sell software, but we are going to be running APPLE articles and listings regularly in Recreational Computing. Also, contact Calculators/Computers magazine, which is devoted entirely to educational computing. (Write C/C, Dymax, P.O. Box 310, Menlo Park CA 94025). - The Dragon.*

## MATHEMATICIANS ATTEMPT ENGLISH!

*For some time, Peet's Coffee, Tea and Spice Shop has been my early morning conference room. (If you get to Menlo Park, do join us there!). Among the creatures who frequent Peet's are the denizens of the Math Dept at Menlo College. Recently, these mathematical beings have been trying to learn to write with words instead of squiggles. This is one of their first efforts, a letter to me.*  
- The Dragon.

PEETS

Sept 11, 1978

Robert D. Albrect

PEETS COFFEE SHOP

SANTA CRUZ AVE.

MENLO PARK, CA

USA: 94025

Dear Bobby

I AM IRATE  
FILLED WITH  
VIOLENT ANGER  
AND SHOCKED.

PLEASE STOP  
WHATEVER IT  
IS YOU ARE DOING.

THANK YOU.  
SINCERELY,  
RESPECTFULLY  
YOURS.

J. CONLAN

Jconlan

M. Thibodeaux

# ARTIFICIAL INTELLIGENCE

BY DAVID CUDHEA

PART 1

*This article is the first of a two part serialized presentation of the differences in two schools of thought on the future of high-level Artificial Intelligence. Stanford's Edward Feigenbaum and John McCarthy represent two of the key persons within the academic community about which these differences revolve.*

*Formerly a writer for the General Secretary's Office at Stanford University, David Cudhea has moved to Boston, where he stoically "survived the flu, a snowstorm and getting used to Harvard." He is now editor and writer for the Harvard University Development Office.*

Not quite ten years ago, an international grand master of chess, Great Britain's David Levy, wagered £1,250 that no computer program could beat him at the game within a decade. Stanford's John McCarthy and three other equally eminent computer scientists (from M.I.T., Princeton, and Edinburgh) took him up.

Levy is ahead, thus far. The final test match is scheduled for this summer, and if I were to bet on it, I'd bet on Levy (sorry, John). One more time. Next time, I'll bet on the machine.

A program named Chess 4.6 is at present expected to play Levy. Two years ago Chess 4.6 entered class B at the Paul Masson Tournament, wiped out 128 good amateurs, and nominally "won" a \$750 prize. One year ago, Chess 4.6 entered the Minnesota Open. Against ranked competitors it won, 5 to 1. It is now officially rated as a master in its own right (2,271 points). Standing next to the board, almost ready to take over, is its successor, Chess 5.0. If it can be got going properly, "we could really put a dent in Levy," the inventor, David Slate of Northwestern University, told the *New York Times*.

The point is that the race, even now, is going to be a great deal tighter than anybody ten years ago would have believed possible—anybody, that is, but a

---

Based on an article in the Stanford Magazine, Spring/Summer, 1978. Reprinted by permission. Some material used in this article excerpted from Margaret A. Boden, *Artificial Intelligence and Natural Man*. New York: Basic Books, Inc. 1977. Also published by Harvester Press in England in paperback (Open University Set Book) and hardcover.

---

few redoubtable adherents of what has come to be known as "artificial intelligence."

Are Chess 4.6 and Chess 5.0, both artifacts, "intelligent?" How, for that matter, might you determine whether or not a particular machine (computer program) is intelligent (has the equivalent of human intelligence)?

There is a test, of course. It is called the Turing Test, after the late British mathematician A.M. Turing, who proposed it 30 years ago. Here is how the Turing Test is commonly, and rather loosely, conceived:

*Sit down at the keyboard of your computer terminal. Converse for half an hour, via the keyboard, with whomever/whatever is at the other end of the line. At the end of the conversation, can you, an "intelligent layman," decide whether your respondent is a computer program or a human? If you cannot, and the respondent is in fact a program, then the program has human intelligence.\**

No computer program has yet been deemed to have passed this test in full.

Yes, we know Levy won!  
More next issue.



Chess programs, for example, really don't have much to say beyond pawn to king four, en passant, gardez la reine, check, and mate. However Turing-successful such limited programs may be within their spheres, there is no Turing-successful general program, for the moment.

How long will the moment be?

No doubt you remember HAL, the computer program that saw, remembered,

---

---

\*The real Turing Test, or what Turing called the "imitation game," involves three people: a man and a woman in one room and an interrogator in a separate room. The object of the game is for the interrogator to determine which of the two people is the man and which the woman by asking them questions which they answer in writing or typewriting or through an intermediary. A variation of the Turing Test replaces the man with a machine.

---

---

thought, talked, ran the spacecraft, and went crazy in the Kubrick film and Clarke novel *2001*? No doubt you suppose, as I used to, that HAL, if he isn't with us tomorrow, will be very soon thereafter?

I, and you, suppose wrong. The coming of HAL has not yet been registered, will not be announced tomorrow, and may or may not be achieved by the first year of the twenty-first century. The problems

---

---

### SEVEN PRINCIPLES OF ARTIFICIAL INTELLIGENCE (as seen by the Heuristic Programming Project)

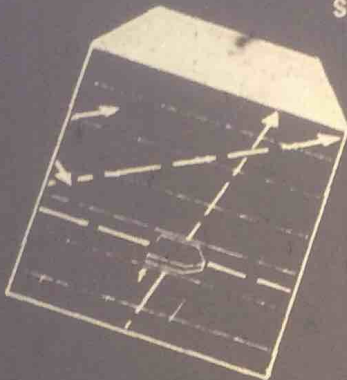

**Generation-and-test:** Omnipresent in our experiments is the "classical" generation-and-test framework that has been the hallmark of AI programs for two decades. This is not a consequence of a doctrinaire attitude on our part about heuristic search, but rather of the usefulness and sufficiency of the concept.

**Situation => Action Rules:** We have chosen to represent the knowledge of experts in this form. Making no doctrinaire claims for the universal applicability of this representation, we nonetheless point to the demonstrated utility of the rule-based representation. From this representation flow rather directly many of the characteristics of our programs: for example, ease of modification of the knowledge, ease of explanation. The essence of our approach is that a rule must capture a "chunk" of domain knowledge that is meaningful, in and of itself, to the domain specialist. Thus our rules bear only a historical relationship to the production rules used by Newell and Simon (1972) which we view as "machine-language programming" of a recognize => act machine.

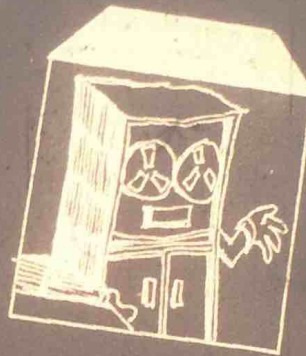

**The Domain-Specific Knowledge:** It plays a critical role in organizing and constraining search. The theme is that in the knowledge is the power. The interesting action arises from the knowledge base, not the inference engine. We use knowledge in rule form... in the form of inferentially-rich models based on theory, and in the form of tableaux of symbolic data and relationships (i.e., frame-like structures). System processes are made to conform to natural and convenient representations of the domain-specific knowledge.

**Flexibility to modify the knowledge base:** If the so-called "grain size" of the knowledge representation is chosen properly (i.e., small enough to be comprehensible but large enough to be meaningful to the domain specialist), then the rule-based approach allows greater flexibility for adding, removing, or changing knowledge in the system.



**Line-of-reasoning:** A central organizing principle in the design of knowledge-based intelligent agents is the maintenance of a line-of-reasoning that is comprehensible to the domain specialist. This principle is, of course, not a logical necessity, but seems to us to be an engineering principle of major importance.

**Multiple Sources of Knowledge:** The formation and maintenance (support) of the line-of-reasoning usually require the integration of many disparate sources of knowledge. The representation and inferential problems in achieving a smooth and effective integration are formidable engineering problems.

**Explanation:** The ability to explain the line-of-reasoning in a language convenient to the user is necessary for application and for system development (e.g., for debugging and for extending the knowledge base). Once again, this is an engineering principle, but very important. What constitutes "an explanation" is not a simple concept, and considerable thought needs to be given, in each case, to the structuring of explanations.

are enormously complex. *Vide* Stanford's McCarthy, director of the Artificial Intelligence Laboratory in the hills behind the campus and one of the grand nearly middle-aged men in a field which has no old men.

"Yes, I've been asked now and again about HAL," says John McCarthy. "I have a line for the occasion. HAL is exactly 1.7 Einsteins, 3 Faradays, and 3 of a Manhattan Project away."

Massive conceptual breakthroughs and discoveries, in other words, will be necessary, accomplished by humans of genius followed up by a heavy concentration of resources on hardware-software systems. McCarthy, underscores the last point because it is last, not first. "No one," he says, "is now in the position to say, 'Give me a billion dollars and I'll give you a machine smarter than a man in a general way.'"

McCarthy is well known in the field of artificial intelligence—to which he has made notable, even seminal contributions—as being brilliant, quirky, and outspoken. He sees a primary need for theoretical, basic research leading to the identification of what might be called the components of general intelligence. By no means everyone involved in AI would agree, nor would they be wont to suggest that HAL's advent may be so soon unlikely as McCarthy thinks.

Whereas it used to be *de rigueur* in AI to concentrate on the power of *methods*—the reasoning "engine" a robot might use to perform intelligent acts—it is now considered more productive to concentrate on acquiring and representing to the computer the specialized *knowledge* a robot might possess.

Whereas McCarthy believes that we don't yet know how to represent *commonplace general knowledge* well enough so that a general purpose robot can understand and act on it, many other AI specialists hold that the problem can be sufficiently solved through research and development of ways to represent *vast quantities of specialized knowledge*. "Some people give this much larger relative importance than I do," McCarthy admits. "They believe that what's required for the achievement of general intelligence is the codification of large amounts of knowledge from particular fields."

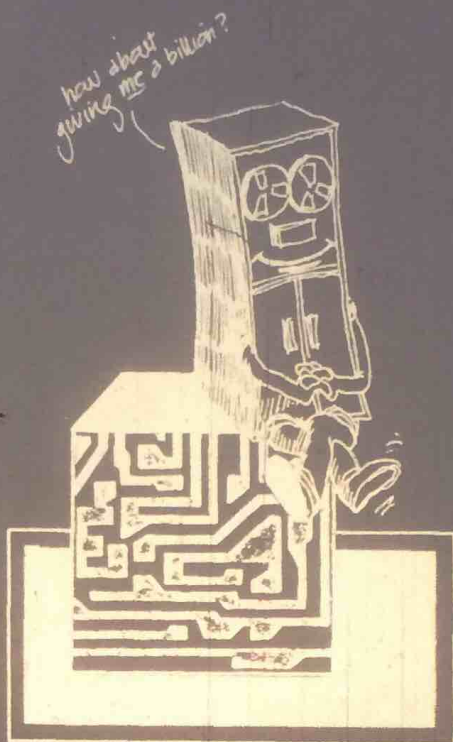

You can find that point of view strongly advocated at M.I.T., the East Coast center of artificial intelligence research. As they recently noted in a journal article, analysts I. Goldstein and S. Papert have ascertained a "paradigm shift" in the discipline. "The fundamental problem of understanding intelligence is not the identification of a few powerful techniques," they write, "but rather the question of how to represent large amounts of knowledge in a fashion that permits their effective use and interaction."

At Stanford, that viewpoint emanates from Polya Hall, headquarters of the Computer Science Department. The chairman, Edward A. Feigenbaum, holds forth there in part on the strength of his 12 years of experience in directing one of the longest-running projects in the AI game: the Heuristic Programming Project. Out of this line of activity have come, for example, a medical computer program that diagnoses infectious diseases and recommends what drugs to use and a chemistry program that rivals human experts in figuring out the structures of certain organic molecules. Many more such "knowledge-based" programs are in progress.

"Our [computer] agents must be knowledge-rich even if they are methods-poor," Feigenbaum propounded not long ago. "We must hypothesize from our experience to date that the problem-solving power exhibited in an intelligent agent's performance is primarily a consequence of the specialist's knowledge employed, and only very secondarily related to the generality and power of the inference method employed."

What is the field, "artificial intelligence," to use the name which McCarthy gave it, and which Feigenbaum thinks ought to be changed (see box Cognomenclature)? Put very broadly, as, for example, by Margaret Boden in her superb and extensive survey, *Artificial Intelligence and Natural Man* (New York, Basic Books, 1977), it is the study of intelligence in thought and action. It is *not* the study of computers; they, operating as instructed by computer programs, are simply its tools.

"The digital computer is itself misnamed," points out Feigenbaum, clearly, thoughtfully, and seriously. "It's not primarily a number cruncher; calculation is only a minor part of what computers can do. Most of the time computers are actually at work on generating programs for the next run of things you want to do. What does that involve? Simply going from some language convenient to the user, like COBOL or BASIC or FORTRAN, into the machine's own instruction language. There's no calculation involved in that—it's a translational process, strictly symbol manipulation.

"At the machine level, information is represented as 'bits'—on/off states of devices. You can put together strings of bits to stand for anything whatever: letters, characters, numbers, or any other arbitrary symbol you choose to think about. You can aggregate them, store them, retrieve them, test them, *manipulate* them."

Don't humans manipulate symbols? Isn't human "cognitive activity" understandable as manipulation of symbols?

Good question, says Feigenbaum. Right up the AI alley.

"If you accept that—human cognitive activity is really some kind of simple or complex symbol manipulation—and if

## COGNOMENCLATURE

"Artificial Intelligence" (AI) strikes some people as a contradiction in terms. If something is not human, it can't be intelligent.

That's debatable. But in any case, those who work in AI generally subscribe to the viewpoint expressed to me by Stanford's John McCarthy: "There is no barrier, in principle, to achieving human-level intelligence with machines."

McCarthy indeed goes well beyond this. "[Future] generations of computers," he has written, "would produce an intelligence that might be qualitatively like that of a human, but thousands of times faster. What would it be like to be able to put a hundred years of thought into every decision?"

Well, it takes me a long time to make up my mind anyway. Would the computer's results be qualitatively any better? Answers McCarthy "We'll have to try it and see."

The term "artificial intelligence" also strikes fear into some people and hostile sparks from others. Again, this is probably because "intelligence" strikes them as uniquely human, never to be ascribed to, much less possessed by a "machine."

"There's a real barrier here in trying to explain to people what it is we're doing,"

Stanford's Edward Feigenbaum told me. "Even more important, the term AI doesn't really describe what we are doing," he went on.

The field has not been primarily oriented to technology. Instead it views itself as that part of science which is investigating the *nature of intelligence as information processing* whether that intelligence manifests itself in natural systems [humans] or in computational systems. The essence of the field is not to create a machine brain but to understand what intelligence is all about.

"Philosophers and psychologists have been studying this for centuries. The impetus given to modern studies was the advent of the digital computer."

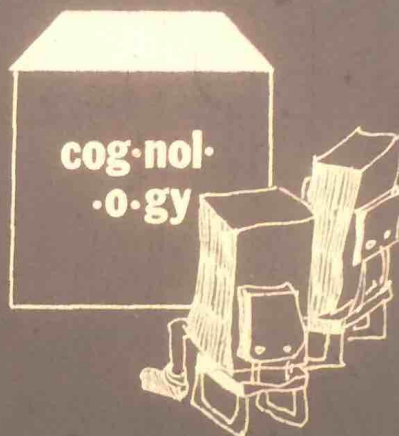

Perhaps the name of the field ought to be changed, then, from AI to something else. What?

Feigenbaum favors "cognitive science," and many others also support the movement toward that term.

"It's different from 'cognitive psychology,'" Feigenbaum says, "in that it's broader. It does include those aspects of cognitive psychology of interest to the people building computer models. It also includes linguistics, mathematical and logical studies, computer science studies. It's the intersection of all those fields. And it presents the right image of what the field thinks it's doing."

In addition to his many other contributions to the field of AI, John McCarthy named it AI, in 1956.

How does he feel about retitling it?

He sighs, gazes at his computer terminal, rocks in his chair. What's in a name? "I would sort of go for changing it to 'cognology,' or something like that," he says wryly.

"We ought to pick a name that is analogous to those of the other [hard] sciences," he declares. "I'd like it to be more analogous to geology than to library science." —DC

digital computers are, as they are, general symbol-manipulation systems, then it follows that you can *model* cognitive activities using computer programs, and thereby study them.

"The job of a cognitive scientist is to create programs that model human cognitive processes—problem solving, learning, memory, perception—so that we can understand them in detail in the same way that we can understand all other naturally occurring phenomena."

Feigenbaum does not, however, pursue cognitive psychology *per se*. He makes it clear that his main interest is the con-

struction of "intelligent artifacts"—in his case, computer programs that act like human experts in particular fields. McCarthy approaches AI with somewhat different objectives in mind: he's interested, from a more theoretical perspective, in uncovering principles, methods, and techniques useful in such construction. "Some experiments are designed, yes, to achieve specific goals comparable to human performance," he explains. "Others are designed to study the intellectual mechanisms involved, to see if we can understand *them*." (Obviously, both approaches may shed some light on human processes, too, insofar as any model can.)

Cross-currents of definition have swirled and eddied through and around AI since its very birth. I myself find handy the definition coined by the former director of M.I.T.'s AI lab, M.L. Minsky. "Artificial intelligence," he said, "is the science of making machines do things that would require intelligence if done by men."

To which Feigenbaum appends, at least to the inner circle in Polya Hall: "It's still more art than science."

Art or science, and however you may otherwise define it, Stanford is a world center for doing it. The manifestations are various and intriguing.

Down on the campus, Feigenbaum *et al.* pursue and capture specialized knowledge from all kinds of human experts and craft it into such programs as MYCIN (infectious diseases) and DENDRAL (molecular structure). Collaborators over the years have included geneticist Joshua Lederberg, chemist Carl Djerassi, and pharmacologist and DNA researcher Stanley Cohen, to name a few. Feigenbaum thinks of this branch of AI as "knowledge engineering." The "engineer" works intensively with an expert to acquire "domain-specific" knowledge and organize it for use by a computer program. The program then can be used to assist human specialists and, not infrequently, to amplify *their* knowledge. A program called META-DENDRAL infers rules of fragmentation of molecules in a mass spectrometer. In one stringent test META-DENDRAL discovered usable rules (experts said they were excellent) for members of a family of complex ringed molecules for which the mass spectral theory had not been completely worked out by chemists.

Up in the foothills, at the AI center proper, McCarthy *et al.* are pumping some rather different bassoons, some old, some new.

*Vision, industrial assembly, etc.* Through the use of television cameras, computer programs are made to "see" scenes; that is, to see as much of those scenes as may be necessary for the computer program's purposes. Industrial assembly is one such purpose. An early "hand-eye" and program combination developed by the AI team could put together, correctly, the water pump from a Model T Ford, and its successors are grappling with the rest of industrial engineering history. "Arm-hand" research is part of this, naturally. By extension, so is robot "navigation." Many scientists foresee the day when automobiles, say, will drive themselves, park themselves (if they can find a space), and come back on call to pick up passengers. Talk is cheap and easy; the necessary research and development, of both hardware and software, is arduous and expensive.

*Automatic programming.* These efforts focus upon designing programs that design programs. Already, of course, programs routinely create programs, in the sense that one brief instruction in a high-level programming language may call

up one or more extended and complex series of instructions in a more detailed language, such as machine code itself. But let's go beyond this. For problem solving, for the creation of true "artificial intelligence," programs that not only write other programs but can then rewrite them if necessary are essential—to capitalize on "learning" they will have to *reprogram*. Also related to programming are researches in theorem proving and the mathematical theory of computation, useful in proving properties of computer programs and generating programs having prescribed properties.



*Understanding natural language.* What you and I understand, we often get as much from context, and from our knowledge of the world, as from the words that may be said to us. Much knowledge is implicit rather than explicit. How can we give this tacit dimension to the mind of a robot? Some say the problem can be solved through the attack on the problem of understanding, and representing, natural language. Until it can speak (type out) a reasonably comprehensive brand of English, no robot will ever pass a Turing Test. Stanford's Terry Winograd considerably clarified the nature of the difficulties, and the possibilities of natural-language computer programs, in his M.I.T. project called SHRDLU (see box). Now he and his collaborators are making progress on a computer language that will be specifically oriented to the problems of "knowing" that are part and parcel of the problems of "under-

standing"—language and more. It's called, functionally enough, Knowledge Representation Language (KRL).

*Formal models.* If it is difficult to express what humans know about the world in natural language, it is also difficult to express what we know in formal mathematical or symbolic logic. Again, the problem is "representation." John McCarthy might be described as a premier formalist. And his statement of what he's after has a certain rigorous ring to it (see box): "the representation of the world in such a form that the solution of problems follows from the facts expressed in the representation."

*Time-sharing and home computers.* Lest you conclude that the AI center and McCarthy are nothing but abstruse and more abstruse, please also note that the center is in the forefront of applications destined for functional existence sooner rather than later. One such concerns the coming of the computer as everybody's homebody—message taker, message sender, accounts manager, game-board, etc. Stanford is now working on the protocols (entry codes) for a national citizen's computer network. Its title is DIALNET; it would link time-sharing computers, throughout the country and perhaps the world, with each other, using ordinary dial-up telephone networks. It would parallel in this respect the already existing network called ARPANET, sponsored by the Advanced Research Projects Agency of the Department of Defense. Hundreds of universities, industrial research centers, and the like are already tied into that network. McCarthy or Feigenbaum can put a message through to a colleague at M.I.T. or at the University of Oslo in ten seconds (after they keyboard it).

There is a computer terminal in the office of many Stanford computer scientists. McCarthy and Feigenbaum, for example, can easily agitate each other's viewing screens, but I am not sure how often they do. As practitioners and theorists of AI, the two are brothers in a growing band of professionals making ever more interesting music together. A band is also a spectrum, however, and considered in relation to it, McCarthy and Feigenbaum can be said to stand at the opposite polar extremities. □

To be continued next issue

## SHRDLU

Stanford's Terry Winograd, when he was at M.I.T., devised (and named) SHRDLU as part of a project on understanding natural language. *You understand natural language without thinking (much) about it. If you did think much about it, you would probably stumble in your understanding, just as you would stumble in your walking if you thought out every movement before making it. How, then, can a robot be made to "walk" or "think" or understand your natural language? Winograd doesn't know either, but he's working on it; his current project is "Knowledge Representation Language" (KRL). SHRDLU was a pioneering earlier program through which a robot could be made to answer questions, execute commands, and accept information in English. It can't "see," but it can "locate" things if given x-y coordinates on a grid. It can "move" things. The following dialogue between Winograd (lightface type) and SHRDLU (boldface type) shows how:*

1.  
Pick up a big red block.  
OK.  
*The system answers "OK" when it carries out a command. In order to pick up the red block, it had to clear it off by finding a space for the green one and moving the green one away. [Figure shows the initial state of the scene.]*

2.  
Grasp the pyramid.  
**I DON'T UNDERSTAND WHICH PYRAMID YOU MEAN.**  
*There are three pyramids in the scene, so the program does nothing.*

3.  
Find a block which is taller than the one you are holding and put it into the box.  
*The system has to figure out what is meant by "one" and "it," as well as using deduction to decide which block it is holding.*

**BY "IT," I ASSUME YOU MEAN THE BLOCK WHICH IS TALLER THAN THE ONE I AM HOLDING.**

*Printed out to keep us informed.*

OK.  
*The hand has to set down the red block to pick up the taller blue one.*

4.  
What does the box [now] contain?  
**THE BLUE PYRAMID AND THE BLUE BLOCK.**

5.  
What is the pyramid supported by?  
*Earlier the system responded to "the pyramid" by saying "I don't understand which pyramid you mean." Now, it assumes that we mean the one just mentioned.*

**THE BOX.**

6.  
How many blocks are not in the box?  
*Negatives such as "not" and "no" are handled whether they appear in clauses or noun groups (such as "no boxes").*  
**THREE OF THEM . . .**

35.  
Is there anything which is bigger than every pyramid but is not as wide as the thing that supports it?

*The system understand quantifiers such as "every," "any," "some," etc., and structures such as "bigger than," "as wide as," etc. Here "it" refers to a noun group*

*within the same sentence but two levels up in the parsing tree.*

**YES. THE BLUE BLOCK.**

36.  
Does a steeple . . .  
**SORRY, I DON'T KNOW THE WORD "STEEPLE."**

*The system interrupts immediately when it sees a word it can't figure out.*

37.  
A "steeple" is a stack which contains two green cubes and a pyramid.  
*The quote marks indicate that we are defining a new word.*  
**I UNDERSTAND.**

38.  
Are there any steeples now?  
**NO.**  
*The new definition is used as a description to recognize steeples . . .*

43.  
Is there anything to the right of the red pyramid?  
**YES, FOUR THINGS: THE BOX, THE RED CUBE, THE BLUE PYRAMID AND THE BLOCK NAMED SUPERBLOCK.**  
*Once an object has a name, the name is used to help identify it in responses.*

44.  
Thank you.  
**YOU'RE WELCOME!**  
*Idioms can be defined without modifying the grammar.*

Source: Margaret Boden, *Artificial Intelligence and Natural Man* (New York, Basic Books, 1977). Also available: Harvester Press, England (paperback and hardcover).

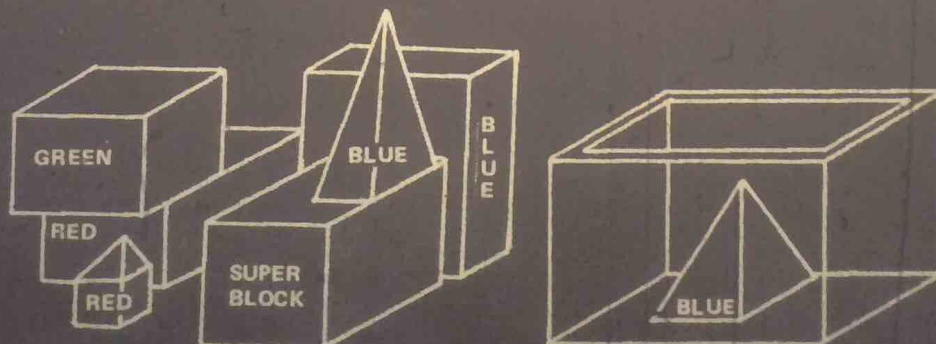

# A Letter from your Publisher



Many changes have taken place over the past several months here at People's Computer Company, all of which bode well for our publications, the future of our company, and for you, our readers. These changes will improve our products and services... improvements that you will benefit from in the delivery and quality of our magazines and books.

The most apparent change: our old standby, *People's Computers*, the first magazine in the home and personal computing field, is now *Recreational Computing*. It will feature more games, fantasy, science fiction, graphics, art, music, puzzles and problems, free software, languages, tutorials, interviews, and many other things of interest to the serious hobbyist. We have new editors for all three of our periodicals. In September, Bob Albrecht returned to PCC to once more become editor of *People's Computers - Recreational Computing*; he shares his editorial functions with Louise Burton and Ramon Zamora. In October, Suzanne Rodriguez took over the editorship of *Dr. Dobb's Journal* and Curtis Roads joined us as editor of the *Computer Music Journal*.

We have appointed the following new department heads: Michael Madaj as circulation manager, Sara Werry as production manager, Cynthia Kosina as head of wholesale distribution. All three of our new managers have been with PCC for some time, so are experienced in our way of operating. It was with regret that we had to terminate our bookstore operation, but we could no longer support the losses we were sustaining. All of the above changes were made to help implement our goal of producing magazines and books that inform and entertain our readers.

A note on mail service: as of January 1, 1979, we will actively discourage surface mail to most foreign countries. We encourage readers to take advantage of first class service to Canada and airmail to all other foreign destinations. It takes months, literally, for our publications to reach Europe, Asia, and Latin America, assuming that they reach their destination intact! The uncertainty of delivery, both foreign and domestic, is extremely annoying to you, our readers and subscribers, and a very real headache to us. Thus our decision to change our policy. There will be no surface mail option available to *Computer Music Journal* subscribers because of its content.

Our new subscription rates for one year are:

	U.S. 2nd class	Canada 1st class	Foreign via air	All Foreign Surface
<i>Recreational Computing</i>	\$10	\$17	\$23	\$14
<i>Dr. Dobb's Journal</i>	\$15	\$25	\$33	\$20
<i>Computer Music Journal</i>	\$20	\$24	\$28	—

Two year subscriptions are also available.

Another, rather drastic change is our decision to accept advertising in all three of our periodicals. As we have no outside funding, we must supplement our income through advertising. Some persons were concerned that we might lose our objectivity concerning products that we would advertise; this should not be the case, however. We are a non-profit, tax-exempt, educational corporation. We have neither stockholders to placate nor dividends to pay; thus, since profit is not our motive nor reason for existence we feel that our objectivity will never be compromised.

On to other topics! The one that gives us the most trouble and loads us down with letters and phone calls of complaint is the lateness and non-delivery of our periodicals to you, our readers. I could relate an endless litany of what can—and has—happened in the production and circulation of our magazines, but I won't, only because your tears of sympathy could stain this magazine so badly that the copy would become illegible (which is sometimes a problem with our printing)... There are many things that can cause delays in the production and circulation of a magazine. We have pretty well licked one of the main ones (under our power) by getting our copy to the printers on schedule, six weeks prior to the month of issue. From that point, we are powerless to the vagaries of Murphy's law: at the printers, the presses may go down, or, as is the problem now with the West Coast paper mills on strike, a paper shortage causes us problems of availability, shared by many... after it is printed, the magazine has to be labeled, bundled, sorted and delivered to the post office, all time-consuming... at the post office, ah, the post office, our poor little magazines can disappear into the second class maw and may not reappear for weeks or even months... and when they do appear the top magazine in each bundle of 30 or so has a better-than-average chance of losing its mailing label... and to boot, second class mail is just about the slowest of all mail service... (Are you crying yet?)... As a good (?) example, my own personal copies of our magazines take about three weeks to be delivered to me in Palo Alto, only 35 miles from our mailing house in San Francisco!

When a letter or call complaining of our (?) service arrives, we go through a very extensive checking process—there is one thing we try never to do, and that is to ignore a letter of complaint. If your complaint can't be solved on the spot, as many can, we will send you a letter or postal card to let you know that we are working on it.

In closing I must thank you for your patience and forbearance in coping with some of the problems described above. I also want to thank those of you who have responded to our request to add postage to our business reply envelopes. Since we must pay the post office 25 cents for each envelope and card returned to us we really appreciate your thoughtfulness in responding so enthusiastically to our request. We all appreciate receiving comments and suggestions that will improve our service and our product. Mail them to me or to the department they concern (this applies to complaints, too).

Thank you again,

Willard Holden  
Executive Director and Publisher

# TRS 80: The MEMORY GAME

BY RAMON M. ZAMORA

Here is a fascinating game to play on your TRS-80. It is called The Memory Game and is based on a HP-67 calculator routine by Sam Gaylord that appeared in the charter issue of *Recreational Programmer*. (See the review section of this issue of *RC* for additional information on this new periodical.)

The game involves trying to remember a number that is flashed on the screen for about one second. The game is adaptive. If you correctly remember the first few numbers, the program begins to

lengthen the number of digits that are flashed. The game starts with five digit numbers and progresses, based on your proficiency, up to nine digit numbers. If you miss a number, the program automatically reduces the length of the next number being presented. A game consists of a series of ten numbers. At that point the program asks if you would like to play again. An option that allows the player to retain the previous difficulty level is also presented at the end of each game. This is a fast paced, fun game to play.

The game can be modified for younger players by altering lines 110 and 122. Line 110 contains the data that are used as scalar multipliers to produce the five to nine digit random numbers. Making these values smaller will cause the program to flash smaller numbers on the screen. The variable, T1, in line 122 controls the length of time the numbers are kept on the screen. Setting T1 to a larger value will cause the numbers to be displayed for a longer time.

Have fun with this clever game!!

```

80 REM ** THE MEMORY GAME 16K LEVEL II BASIC TRS-80 **
85 REM ** BASED ON AN ARTICLE BY SAM GAYLORD IN **
90 REM ** RECREATIONAL PROGRAMMER VOL.1, NO.1,9/78 **
95 REM ** REPROGRAMMED FOR TRS-80 9/15/78 **
100 DIM D(7)
105 DEFDBL M,P,R
110 DATA 1E5,1E5,1E6,1E6,1E7,1E8,1E9
120 FOR I=1 TO 7: READ D(I):NEXT
122 T1=700:GOTO 6000
125 F=1
127 C=10:S=0
130 R=RND(0)
140 M=INT(R*D(F))
145 CLS:PRINT CHR$(23)
150 PRINT@460,,:PRINT USING "#####";M;:GOSUB 2000
155 CLS:PRINT CHR$(23)
160 PRINT@832,"WHAT WAS NUMBER--";:INPUT P
170 IF M<>P THEN 210
180 PRINT@896,"RIGHT";:S=S+1
190 IF F<7 THEN F=F+1
200 GOTO 600
210 PRINT@896,"NOT CORRECT";: IF F>1 THEN F=F-1
600 P=100*(S/(11-C))
605 P=INT(P)
610 PRINT@920,"SCORE EQUALS--";P;"%"
620 C=C-1
625 GOSUB 2000
630 IF C>0 GOTO 130
640 IF P>69 THEN PRINT@0,"YOU ARE VERY GOOD";
650 IF P<=69 PRINT@0,"NOT BAD. I BET YOU CAN DO BETTER.";
660 PRINT@128,"DO YOU WANT TO PLAY AGAIN?";
670 AS=INKEY$:IF AS="" THEN 670
680 IF AS<>"Y" THEN 700
685 CLS:PRINT CHR$(23)
690 PRINT@128,"DO YOU WANT THE SAME DIFFICULTY LEVEL?";
695 AS=INKEY$:IF AS="" THEN 695
696 IF AS="Y" THEN 127 ELSE 125
700 CLS:PRINT CHR$(23):PRINT"THANKS FOR PLAYING--BYE";:END
2000 FOR J=1 TO T1:NEXT:RETURN
6000 CLS:PRINT CHR$(23)
6020 PRINT" THE MEMORY GAME"
6025 PRINT:PRINT:PRINT"THE OBJECT OF THIS GAME IS TO"
6030 PRINT"REMEMBER THE NUMBERS THAT WILL"
6035 PRINT"APPEAR ON THE SCREEN."
6040 PRINT"THE BETTER YOU ARE AT RECALLING"
6045 PRINT"THE NUMBERS THE LONGER THE"
6050 PRINT"NUMBERS GET. IF YOU BEGIN"
6060 PRINT"TO MISS THE NUMBERS THEY WILL"
6065 PRINT"AUTOMATICALLY BECOME SHORTER."
6070 PRINT"HIT ANY KEY TO BEGIN PLAY--";
6080 AS=INKEY$:IF AS="" THEN 6080 ELSE 125
    
```

Initialization of data.

Generate number and display it.

Take player's answer and compare it to generated number. Increase or decrease difficulty level.

Tally player's score.

Check for end of game, replay, and retaining difficulty level.

Delay routine.

Description of game.



TRS 80:

# MILES PER GALLON PROGRAM

Milan Chepko shares a personal record-keeping system he created to help him manage his "fleet" of automobiles. The program is a good example of an applied home computer software project. Dr. Chepko uses the program to store and display performance data for a car—for about one year. If Detroit is reading this, maybe they will take the hint from Milan's article . . .

BY MILAN D. CHEPKO

Why not, in the future, use the automobile's on-board computer to directly capture and display the kind of data talked about in this article? Oh, well!! I can dream, can't I . . . -RZ

My original Miles-Per-Gallon program in TINY BASIC was written to demonstrate a semi-practical use for my micro computer. This summer, after converting to the TRS-80 system, it was one of the first programs to be rewritten. In the process, I expanded the program to include additional subroutines made possible by a more comprehensive BASIC interpreter.

MILES-PER-GALLON  
Flow Diagram

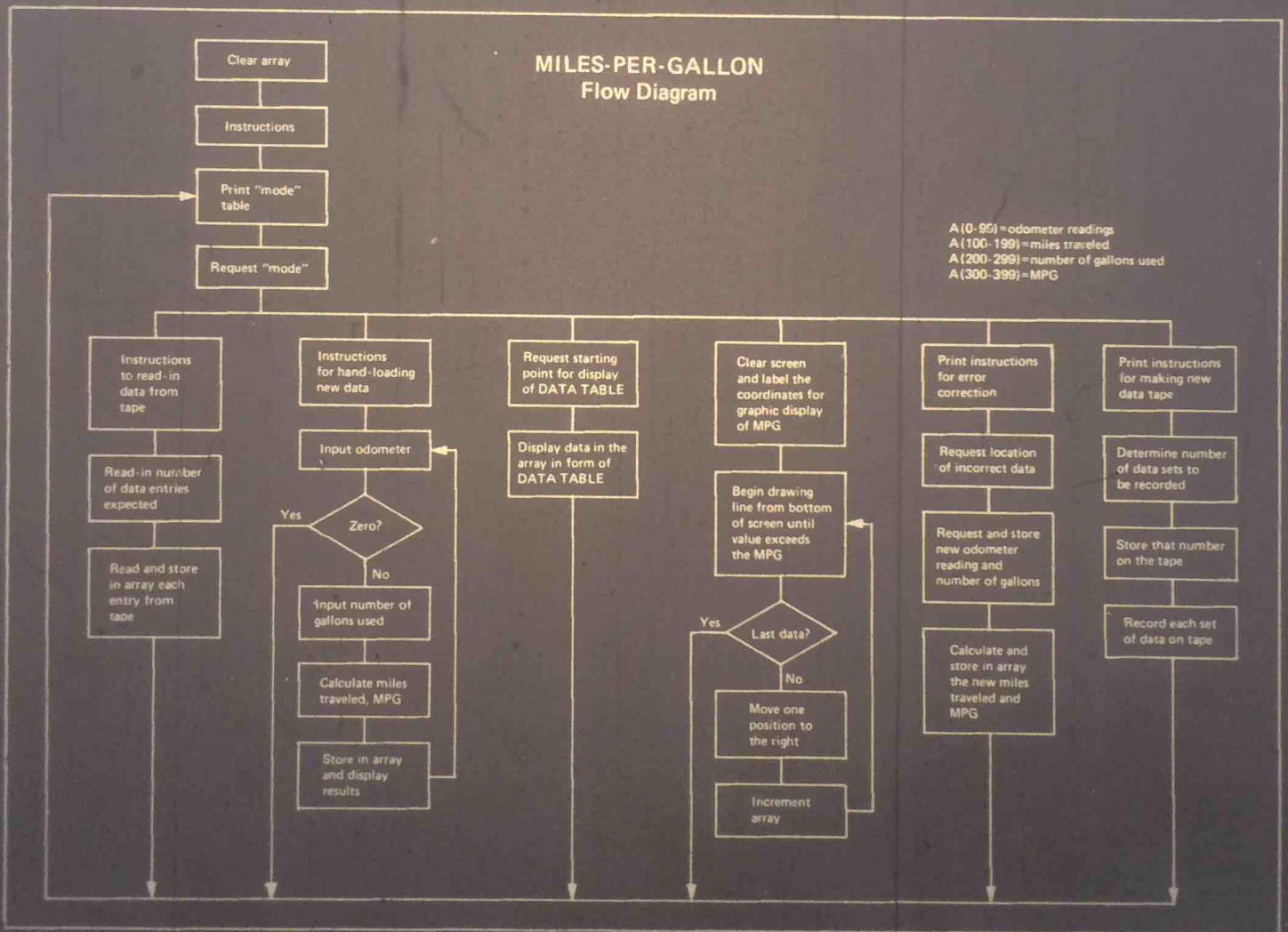



For years, I have collected data on my car's mileage, both to satisfy my general interest and also to keep track of its performance and economy. Often, the day-to-day performance of a car can deteriorate (so slowly) as to be unnoticeable. However, such small inefficiencies can easily be detected by the gradual fall in the economy of operation as reflected in the miles per gallon. To collect the data, I simply note the odometer reading and the number of gallons required each fill-up. The records kept also help me keep the tank more or less full most of the time. This prevents contamination of the gas by water from atmospheric condensation; a real problem in cold weather.

The flow chart shows how the program is divided into several functional blocks; you can delete or expand the blocks to suit your particular needs. The block from lines 80 through 101 collects the

data from the keyboard, computes the number of miles traveled since the last odometer entry, and calculates the miles per gallon. These data are stored in a table that can contain a total of 99 entries. This length, of course, is an arbitrary number and could be changed if necessary. I found, however, that 99 entries makes a convenient length for a data tape and also generates an easily read bar graph.

Also, since none of us are perfect, I included a short subroutine that allows data to be modified after it has been entered into the data table. Since entering data by hand is rather time consuming, I included routines to store data on tape and to read the stored data back into memory. This feature allows you to store information from several cars on a different data tape; alternatively, you could store the information for each calendar

year on a separate tape if that would be more useful.

The subroutine starting at line 160 generates a table that displays all of the accumulated data. At the present time, the data is continuously scrolled into the table starting with whatever data set you designate. Some of you may find it more convenient to modify the program to list perhaps ten entries and then pause until "enter" is hit.

As an afterthought, I decided to use the graphic capability of the TRS-80 to generate a bar graph that displays the miles per gallon for all of the entries in memory. As mentioned earlier, all 99 entries in the data table can fit on the bar graph simultaneously, making overall comparison easy. The last section in the program, lines 210-225, produces the bar graph. □



## TRS 80 MPG Program



```

LIST
8 DIMA(500)
9 CLS:D=0
10 PRINTTAB(7):"*** TRS-80 MILEAGE PROGRAM ***"
11 FORI=0TO400:A(I)=0:NEXTI
12 PRINT:PRINT"PLEASE REWIND AND STORE THE PROGRAM TAPE."
13 PRINT"SELECT A MODE FROM THE FOLLOWING TABLE AND"
14 PRINT"ENTER ITS NUMBER...":PRINT:GOTO20
19 CLS
20 PRINT:PRINT"MODE OF OPERATION"
21 PRINT"-----"
22 PRINT" 1=READ DATA FROM TAPE"
23 PRINT" 2=LOAD NEW DATA BY HAND"
24 PRINT" 3=DISPLAY DATA TABLE"
25 PRINT" 4=DISPLAY DATA GRAPH"
26 PRINT" 5=CORRECT DATA"
27 PRINT" 6=STORE DATA ON TAPE"
28 INPUT"YOUR SELECTION";S
29 IFS=1GOTO50
30 IFS=2GOTO80
31 IFS=3GOTO160
32 IFS=4GOTO210
33 IFS=5GOTO110
34 IFS=6GOTO130
35 GOTO28
50 CLS:PRINT:PRINT"INSERT CASSETTE CONTAINING STORED DATA."
51 PRINT"WITH ALL PLUGS SECURELY CONNECTED AND THE VOLUME"
52 PRINT"SET PROPERLY, ENGAGE THE 'PLAY' BUTTON."

```

Determines the program "mode"

Reads in data from tape

```

53 PRINT:INPUT"WHEN READY, HIT 'ENTER'";AS
54 INPUT#-1,D
55 PRINT:PRINT"THERE WILL BE";D;"SETS OF DATA"
56 FORI=1TOD
57 INPUTS#-1,A(I),A(100+I),A(200+I),A(300+I):NEXTI
59 CLS:PRINT"THE DATA IS LOADED INTO MEMORY. PUSH THE 'STOP'"
60 PRINT"BUTTON ON THE RECORDER AND SELECT A NEW MODE.":GOTO20
80 CLS:PRINT"EACH SET OF DATA WILL BE PRECEDED BY A NUMBER."
81 PRINT"IF AN ERROR IS FOUND AFTER 'ENTER' IS HIT, ENTER '0'"
82 PRINT"FOR THE NEXT MILEAGE AND SELECT THE CORRECTION MODE."
83 PRINT"THEN ENTER THE NUMBER OF THE INCORRECT DATA SET."
90 PRINT:D=D+1:IF D=100GOTO200
92 PRINTD;TAB(10);"MILEAGE=" ";:INPUTA(D)
93 IFA(D)=0 CLS:PRINT"ENTRY OF DATA TERMINATED":D=D-1:GOTO20
94 PRINTTAB(10);"# GALLONS=" ";:INPUTA(200+D)
95 IFD=1 A(100+D)=A(D)+1:GOTO30
96 A(100+D)=A(D)-A(D-1)
97 A(300+D)=INT((A(100+D)/A(200+D))*100)/100
100 PRINTTAB(10);A(300+D);"MPG FOR ";A(100+D);"MILES"
101 GOTO90
110 CLS:INPUT"ENTER THE NUMBER OF THE INCORRECT DATA SET";I
111 PRINT:PRINTI;TAB(10);"CORRECT MILEAGE=" ";:INPUTA(I)
112 PRINTTAB(10);"CORRECT # GALLONS=" ";:INPUTA(200+I)
113 A(100+I)=A(I)-A(I-1)
114 A(300+I)=INT((A(100+I)/A(200+I))*100)/100
115 PRINTTAB(10);A(300+I);"MPG FOR ";A(100+I);"MILES"
116 PRINT:PRINT"CORRECTION MODE TERMINATED":GOTO20
130 CLS:PRINT"PLACE A BLANK CASSETTE IN THE RECORDER WITH TAPE"
131 PRINT"IN FRONT OF THE HEAD. CONNECT ALL BUT THE 'EAR'"
132 PRINT"PLUG, AND PUSH THE 'RECORD' AND 'PLAY' BUTTONS."
134 PRINT:INPUT"WHEN READY,HIT 'ENTER'";AS
138 PRINT#-1,D
139 FORI=1TOD
140 PRINT#-1,A(I);",";A(100+I);",";A(200+I);",";A(300+I)
141 NEXTI
142 CLS:PRINT"LABEL AND STORE THE DATA TAPE CAREFULLY!":GOTO20
160 CLS:INPUT"ENTER THE DATA SET NUMBER FOR START OF DISPLAY";Y
161 CLS:PRINT"INDEX";TAB(11);"MILEAGE";TAB(21);"MILES";
162 PRINTTAB(31);"#GAL";TAB(41);"MPG"
163 PRINT"-----"
64 X=0:PRINT@128,"";
65 FORI=YTOD
66 PRINTI;TAB(10);A(I);TAB(20);A(100+I);TAB(30);A(200+I);
67 PRINTTAB(40);A(300+I)
68 X=X+1:IFX=13 X=0:PRINT@128,"";
69 NEXTI
70 PRINT"THAT WAS THE LAST SET OF DATA"
71 INPUT"TO RESUME PROGRAM, HIT 'ENTER'";AS:GOTO19
00 CLS:PRINT"THAT WAS THE LAST ENTRY THIS FILE CAN HOLD!"
01 PRINT"IF YOU HAVE ADDITIONAL ENTRIES, PLEASE WRITE"
02 PRINT"THE CURRENT FILE OUT ON TAPE, AND START A"
03 PRINT"SECOND FILE.":D=D-1:GOTO20
10 CLS:PRINT@128,"MPG";
11 PRINT@192,"40";:PRINT@384,"30";
12 PRINT@576,"20";:PRINT@768,"10";:PRINT@960," 0";
15 X=9
16 FORI=1TOD
17 X=X+1:J=0
18 FORY=47 TO 0 STEP -1
19 SET(X,Y):J=J+1
20 IF J>A(300+I)GOTO223
21 NEXTY
23 NEXTI
24 PRINT@0,:INPUT"HIT 'ENTER' TO CONTINUE";AS
25 GOTO19
EADY

```

Loads new data into memory and computes MPG. Returns to mode table when 0 is entered for next mileage

Allows operator to modify data after entry

Stores data on tape

Prints out table of all data—can start at a designated location rather than with the first entry if necessary

Determines that no more data will fit in current file

Draws a bar graph for MPG data



# Vending Machine gets

## "BRAIN"

BY PETE VANSICKEL

*A really unique computer application right in our own back yard! The fantasy grows large: no more cups that don't appear while coffee runs into your shoes; gourmet selections; winning an It's It; savoring a free empanada and Select-A-Brew at beer break time. Technology and the basic needs once again combine to show what the future could be—if only the world weren't filled with Ding-Dongs . . . —RZ*

This is a story about a vending machine that was given a brain. This machine is in the Stanford University Artificial Intelligence Laboratory (AI Lab), known to its users as "Foosland." The AI Lab is a rather enchanting place a few miles from the central University campus. It is a place where sophisticated research is being conducted using computers; place where miniature robots and computer music are a reality; place where computers are used to solve complex mathematical problems; place where you can sit at a programming terminal and communicate with computer scientists at Massachusetts Institute of Technology or receive the latest news on *The Associated Press* news wire. It's also the home of a computerized vending machine.

But there was a time in the land of Foos when the vending machine didn't have a brain. It seemed every machine in Foosland had a brain. The programming terminals had brains and the printing machines had brains.

Brainless, the vending machine had no control over its actions. It didn't care if all it offered its users to eat were Hostess Twinkies, fruit pies and Fritos Corn Chips. It didn't care if its users had to have exact change to get it to

Reprinted by permission: *The Stanford Daily*. Article originally appeared October 31, 1978, page 3.

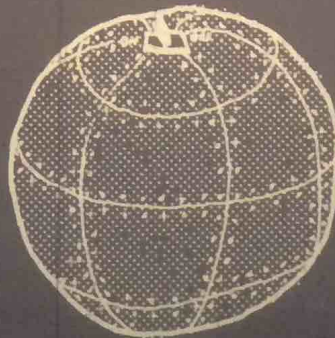
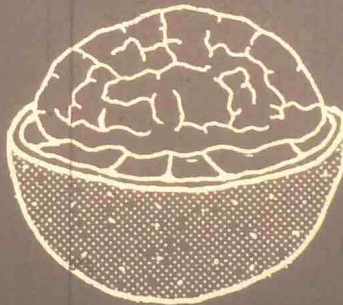
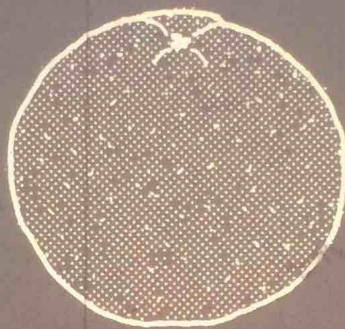

perform. It didn't care if it rejected all your quarters.

Les Earnest, assistant director of the AI Lab, said the basic problem was that no one had enough change or correct change to use the machine. Users couldn't very easily obtain correct change during early morning hours. In addition, no one really liked the food the vending machine company put in the machine, Earnest said.

Researchers at the lab called a meeting, at which various solutions to the problem were proposed. The possibility of having a change machine installed was considered. But change machines are an expensive form of another vending machine. They also require frequent service to install change and insure correct operation. Instead, researchers decided to "give the vending machine a brain," by devising an appropriate computer program to produce vending machine goods. Earnest said, "For a few hundred dollars worth of hardware and some not too complicated programming the vending machine was computerized." Now it has its own teletype terminal for human communication. The teletype is connected to a computer that is programmed to interpret what an individual has selected to eat. In turn, the vending machine then responds by producing the ordered item. Digital Equipment Corporation's KL10 computer "runs" the vending machine which has been named the "Prancing Pony."

The Prancing Pony is so intelligent its users don't need correct change; in fact, they don't need change at all. Users type their Foosland passwords and selections into the computer terminal. The Pony services the request, commands the user to "EAT!" and then sends a bill at the end of the month.

The Pony has a few amusing features. One in every 128 requests is granted free-of-charge to the user. Another added attraction which is a favorite among the AI Lab musicians is the option to "Flip" for the cost of a selection. Leland Smith, a musician here, says, "It's the most honest game in town." When a user types the letter "F" after the food selection a program runs that simulates the flip of a coin. If the user wins the toss he gets the selection for free and the terminal types, "You won!" then rings its bell. If the user loses he pays double the cost of his selection. Apparently musicians have reputations for gambling on "Flip" more often than other computer scientists. "Musicians live dangerously," Smith said. He plays because he "likes to get a free lunch once in a while."

In order to implement all this new vending machine procedure several researchers at the AI Lab negotiated with the vending company and bought the machine from them. People soon started stocking the machine with items such as delicatessen sandwiches, yogurt, cottage cheese, pork buns, potstickers, and a Chilean specialty, empanadas. The Pony also serves cold Budweiser, Tuborg or Rainier. The computer, scanning data on the user, can check his age though. Anyone under 21 won't be served.

Charlie Hasselbach, an AI Lab secretary said she stocks the Pony once each morning and once in the late afternoon.

The Prancing Pony has been satisfying the snacking appetites of people of Foosland for six years. So then, why haven't vending machine companies taken up the banner of the computer revolution that's been going on all around us for 10 years or more? Earnest said several people from vending companies visited the AI Lab when the Prancing Pony was first implemented but he hasn't heard from anyone since. Earnest said the Pony is unique. He attributes this lack of response to "technological lethargy." People who manufacture vending machines don't understand computers. Making a computerized vending machine requires an understanding of both computers and vending machines. "Apparently it takes too much time and energy to convince manufacturers this is the way to go," Earnest said. □

# alice in collapsar-land

BY WARWICK SLOUGH

*Warwick's first fiction story All In The Mind ran in the last issue of RC. He returns this issue with something he refers to as "a short piece of whimsy." It seems, from the ending to this story, that we will be hearing more from Mr. Slough. We certainly hope so . . .* —RZ

Alice was beginning to get very tired of sitting by herself in the spacecraft with nothing to do. She was considering in her own mind whether the pleasure of making a meteor assembly would be worth the trouble of getting the meteors, when suddenly a white astronaut with pink eyes passed close by outside. There was nothing particularly remarkable in this, but when the astronaut took out a large silver watch and looked at it and, (as she sensed), said to himself, "Oh dear! Oh dear! I shall be too late," she thought it a trifle singular.

Quickly starting the impulse units she was just in time to see the astronaut move towards a large, rotating black hole. In another moment down went Alice after it, never once considering how in the space-time continuum she was to get out again. Her attention however was suddenly diverted by an apparently identical astronaut who pulled a corresponding watch from his pocket and, (as she once more sensed), muttered, "Oh dear! Oh dear! I shall be early—I shall be early!" This would have been more than a little confusing, had she not instantly realized that the rotating black hole must also have been *charged*,\* and

\* According to present cosmological theory, in any other type of black hole both Alice and the astronaut would have already been compressed to a nuclear plasma.

hence both she and the first astronaut had left their original universe and entered a second one where time happened to be flowing backwards. "Oh dear," thought Alice, "such a nuisance, that means I shall be getting younger and younger, and presently I shall not be born yet."

As she travelled through hyperspace into this peculiar universe she tried to remember "You are old Father William" in order to be sure that she could remember things. Unfortunately it came out as:

"You are young Father William," the old man said,  
 "And your head is as bald as a coot;  
 And yet you incessantly stand on your head—  
 Do you think in this state it will suit?"  
 "In old age," Father William replied to his son,  
 "I feared it might give me a sprain,  
 But now that my limbs are like jelly  
 unset,  
 Why I do it again and again."

But that doesn't seem to be right, thought Alice, and I don't much care for this universe—so, missing the naked singularity\*\* by a hair's breadth, she steered for yet another existence—but that is another story . . . □

\*\* Whereas for most black holes it is expected that an event horizon prevents information from being transmitted to an external observer, (due to the very large gravitational effect), in certain circumstances, (depending upon the shape and mass of the collapsing star), information can be leaked from particular black holes—allowing an external observer to record the final compression of matter to a non-existent point—this is the naked singularity.

# a New Algorithm for Chess

PART 1

BY DAVID CHELBERG AND DAVID WATTERS

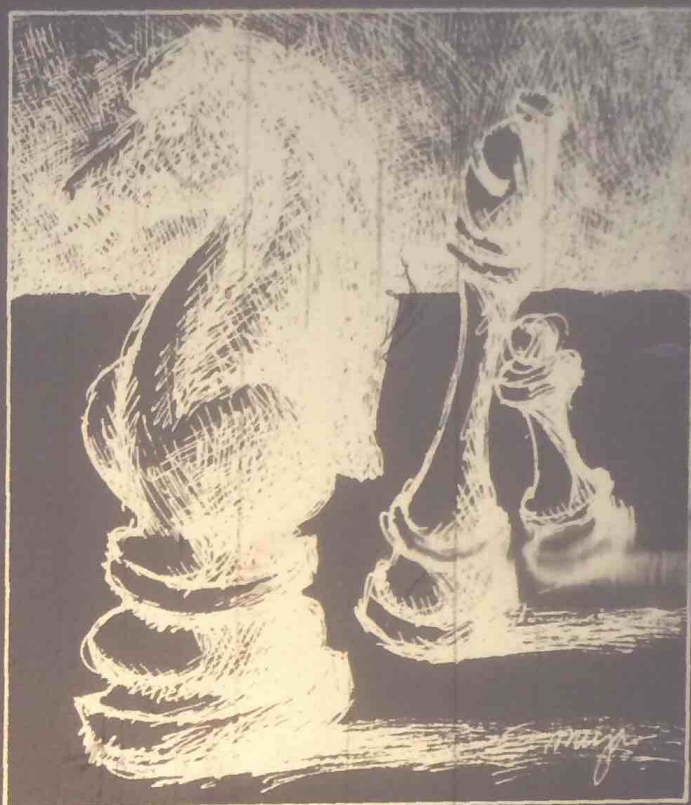

*David & David (D & D?) tantalize us this issue with the first part of a series of articles on a new chess program they have developed. David C. is at Stanford University this term; David W. is at Northwestern University. The two are writing these articles between exams, turkey breaks and Christmas vacations. This part must have been written during exams; there are tear stains on the originals. I expect cranberry tracks on the next installment & eggnog spills on the Christmas issue. Your move D & D!!*

- RZ

Since the advent of the age of computers much progress has been made in solving problems of complexity with the aid of computers. One such problem in which much work has been done is the field of chess-playing computers. In order to fully understand the difficulties of our task in writing a chess program, the history of other programs is helpful.

## SHANNON STARTED IT

The first major attempt to deal with this problem was undertaken by Claude Shannon in 1949. At this time he didn't write a program, but discussed the basic problems involved. The framework he introduced has guided most of the subsequent analysis of the problem.

Shannon observed that chess is a finite game, and that only a limited number of continuations exist at a given moment or even throughout an entire game. He calculated the total number of continuations possible as  $10^{120}$ . Obviously, this number of continuations couldn't be searched through by even the highest speed computers for centuries, so some compromise had to be made.

This is the framework which Shannon suggested:

- (1) Consider alternative moves.
- (2) Obtain effective evaluations of alternatives by means of analysis.
- (3) Choose the preferred alternative on the basis of the evaluations.

The analysis is the most difficult part to set up. Shannon considered it in three parts. First, continuations would be explored to a certain depth. Second, the positions at the end of these continuations would be evaluated on the basis of the pattern and number of men on the chessboard. Lastly, the best alternative would be chosen.

To select an alternative, the process of minimaxing is used. Minimax operations start with the terminal positions, which have specified values. Then, working backwards, a determination is made at

each branch of which move is best, including possible opponent moves. The process continues until the best alternative for the next move is determined.

In Figure 1, for example, there are six possible outcomes. If it is white's move, his best option is move #1 because it assures him of at least a draw.

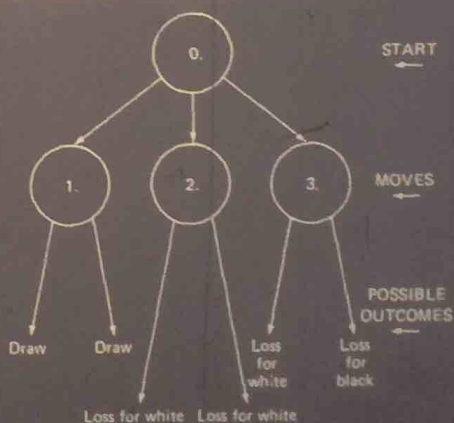

Figure 1. Move Tree Diagram with six outcomes

The way to arrive at this conclusion is this: Consider move #1, this will lead to a draw no matter what black does. Move #2 will lead to a definite loss for white. Move #3 is more interesting, it depends upon what black will do to arrive at the outcome. We can assume, however, that black will make the move

to his best advantage and therefore this move can also be considered a loss. Thus the best move is the first one.

Shannon proposed two sets of answers for these kinds of problems. The first was to search for all alternatives to a fixed depth. Then to evaluate each with a numerical sum; and then to pick the one with the highest number.

His second set of answers considers the possibility of selecting a limited number of continuations. He also discusses the possibility of weighting moves on the basis of blocking, attacking, defending, and other such functions that the chessmen perform.

### TOURING WITH TURING

The first person to propose a specific set of rules to put Shannon's principle into action was A.M. Turing in 1950. He devised a program simple enough to be done by hand, without the aid of a computer.

Turing's program considered all possible moves. He introduced the idea of a "dead" position, that is, one which is relatively stable, and could be evaluated. In the one published game the program lost to a weak human player. Turing's program wasn't very good, but at least it was a step in the right direction.

### LOS ALAMOS GOES CRAZY

In 1956, a group of scientists at Los Alamos programmed MANIAC I, a digital computer, to play chess. The program incorporated Shannon's first principle

in that it considered all continuations to a fixed depth of two moves, made static evaluations and the alternative with the best value was chosen.

In order to simplify the problem to a size reasonable for the MANIAC I computer several factors were changed. The chess board played on was 6 x 6 instead of the usual 8 x 8, and all bishops were removed. Furthermore, both castling and initial pawn moves of two spaces were prohibited.

The result of this programming produced a program capable of beating beginners but still not generally being very good. The average time this program took per move was 12 minutes.

### BERNSTEIN PRUNES THE TREES

In 1958, Alex Bernstein created a chess program utilizing a new function. This function was one of the possible alternatives Shannon considered. In Bernstein's program, only a fraction of all possible moves are considered. These took into account King safety, defense and development.

This program works on a regular chess board and is played under ordinary rules. The level of play of this program and the earlier one at Los Alamos is about the same. The time the Bernstein program takes is about eight minutes per move.

This shows that, even with the greater number of possibilities involved with playing on an 8 x 8 board, the greater selectivity in moves is enough to cancel this effect, and provide a larger search in the same amount of time.

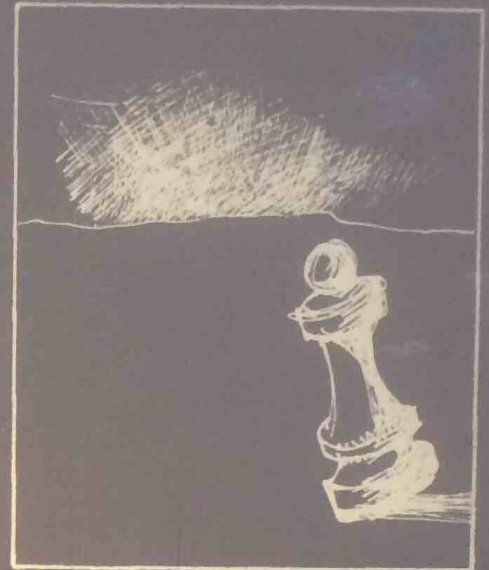

### NEWELL, SHAW & SIMON — A A TRIO OF MOVERS

Newell, Shaw and Simon, in 1958, wrote a chess program incorporating some features of the other programs already mentioned. It used Shannon's basic method, Turing's concept of a dead position, and Bernstein's concept of limiting the number of moves considered. It also used a numerative adding function to compare alternatives.

This program attempts to find moves that meet its specific goals. These goals of King safety, material balance, center control, development, King side attack and promotion are recognized by chess experts to be important to the evaluation in their own games.

After the program finds a move or moves which apply to a goal, it evaluates all continuations statically and uses the process of minimaxing to determine the best move. Minimaxing refers to the process in Shannon's proposal which allows the selection of the best move. The program resolves all continuations until they are dead.

This program takes approximately one to ten hours per move. This figure reflects the complexity of the program and the level of analysis done. Since the program has a variable level evaluation, it is one of the first to vary from Shannon's proposal for fixed level search. In this, it plays better than any of the earlier programs mentioned; however, it is still a weak player.

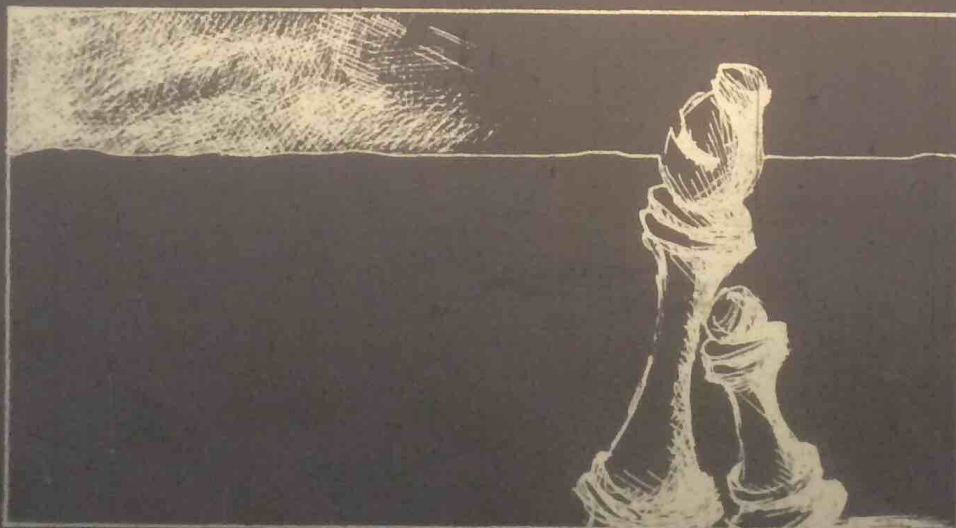

COMPARISON OF SOME EARLY CHESS PROGRAMS

	TURING	LOS ALAMOS	BERNSTEIN	NEWELL, SHAW, SIMON
<u>Vital Statistics</u>				
Date	1950	1956	1957	1958
Board	8X8	6X6	8X8	8X8
Computer	Hand simulation	MANIAC I	IBM704	RAND JOHNNIAC
		11,000 operations/sec	42,000 operations/sec.	20,000 operations/sec.
<u>Chess Program</u>				
Alternatives	All moves	All moves	7 plausible moves	Variable
Depth of Analysis	Until dead	2 moves	Sequence of move generators	Sequence of move generators
Static evaluation	Captures only	Numerical material, mobility	2 moves	Until dead
	Many factors		Numerical material, mobility, control center	Nonnumerical
Integration of values	Minimax	Minimax (modify)	Minimax	Vector of values
Final choice	Material domination	Best value	Best value	Acceptance by goals
	Normal, Best value			Minimax
				1. First Acceptable
				2. Double Function
<u>Programming</u>				
Language		Machine code	Machine code	IPL-IV, interpretive
Data scheme		Single board	Single board	Single board
		No records	Central tables	Decentralized, List structure
			Recompute	Recompute
Time	Minutes	12 min/move	8 min/move	1-10 hrs/move (est.)
Space		600 words	7000 words	16,000 words
<u>Results</u>				
Experience	1 game	3 games	2 games	0 games (1963)
Description	Loss to weak player, aimless	Beats weak player	Pass as amateur	Good in spots (opening)
			Blind spots	

RECENT WORK

Recent work in chess programming has included Northwestern University's Chess 4.6 and numerous other programs which are growing continually more complex with the increased speed of today's large computers. Almost all of the better programs today employ a form of Shannon's strategy of searching a tree of possible moves. However, there are exceptions.

UNIVERSITY OF SOUTHERN CALIFORNIA SNAPSHOTS

The University of Southern California has designed a chess playing program with accompanying specially designed language which does not use Shannon's methods. The program implements a method called "snapshot." What it does is this: It takes a look at the given position and takes pictures of subsequent variations, and generalizes. This program also stores a number of "rules" such as, "keep your knights off the edge of the board." The unique characteristic of this program is that it is able to take advice. When someone plays and can describe an error

the computer made, he may offer advice to the computer. This program is in its beginning stages and looks promising. None of these programs, however, has yet passed beyond the level of a novice after twenty years of work in this field, with the possible exception of Chess 4.6, which has won one game against a master chess player. Its success is due to the huge computational power available to it.

OUR PROGRAM

In writing a computer chess program we had to first decide what it should be able to do, and secondly, what restraints there were on it. For our task of writing this computer chess program our purpose was to develop a program that could play moderately well for the Hewlett Packard 2000 Access Basic System. The main limitations were that the program play according to all accepted chess rules, including a time limit of two hours for the first forty moves, an average of three minutes a move. Furthermore, our space was limited to 200 records and the only available language on this system was BASIC.

To write this program under these restraints we had to decide what kind of strategy to use that would be both quick (requiring little computation), and would conserve space to within our limitations. The limitations precluded using Shannon's tree search method. We also rejected Shannon's limited tree search proposal since we had little confidence in our ability to write a good algorithm for pruning the tree for best results (neither of us are any better than novice chess players). An additional consideration was that Northwestern University's chess program (the current world champion), took several years to develop even though they had several programmers and chess experts, as well as the full resources of their computer center. Thus since we lacked the chess experience and also the computing facilities to successfully implement this traditional approach, we had to develop a different approach. This new algorithm for chess became our current chess program in only a year and a half; however, refinements have continued for another two years. It is this new algorithm which will be discussed in the next issue. □

To be continued next issue



# KEEPING TRACK OF 'MOTHER'

BY ELLEN  
LEVINE



*Back in the days when the Whole Earth Catalog was taking shape in Menlo Park, a like-minded publication was getting underway on the other side of the country—in North Carolina. The new magazine's creed was doing more with less. With that supposedly un-American manifesto, it went on to become one of the great publishing successes of the 1970's. We're talking, of course, about Mother Earth News.*

*People's Computer Company, as many readers know, sprang from the same roots (The Portola Institute) as the Whole Earth Catalog—spiritual cousin to Mother Earth. In the way connections happily evolve in the doing-more-for-less extended family, a home computer project involving Mother Earth is now the subject of an article for Recreational Computing.*

*The Mother Earth project is an index, and as writer Ellen Levine explains, it has been a challenge, particularly since*

*she and her husband Rick are learning a new computer, having to customize programs themselves, setting up a business, and trying to make it all work in a rural setting. The Levines live on a farm outside of Grants Pass, Oregon.*  
—LB

Years ago, I read a science fiction story about a Tibetan lamasery that purchases a computer in order to compile a list of all the possible names of God. The lamas realize that, by hand, this task might take 15,000 years; the computer finishes the task (and, incidentally, destroys the world) in three months.

Like the fictional lamas, my husband and I decided to purchase our microcomputer for a practical reason. However, instead of sorting celestial titles, our computer would be used to sort and alphabetize titles from magazine articles. The product is a complete and cross-referenced subject guide to *Mother Earth News* magazine—an index which we market by mail from our home.

The introduction to our "subject guide" explains how we originated this idea:

"It all started when we tried to remember which issue of *Mother* had that great bread recipe. 'Why doesn't somebody put together an index?,' we complained. And then we realized that we could be that

somebody! We made a pile of all our *Mothers* and stared at the four feet of information. Compiling all this into a subject index, we realized, would be a mother of a task. So, we decided to combine our interest in putting together the index with our interest in microcomputers."

"We believe that the index and the computer can be useful tools if they are used properly. The computer helped us alphabetize, sort, and print every inch of that four-foot pile."

Our interest in the microcomputer has little to do with games or other hobby applications. For us, the central issue of owning a computer is that it be practical. The system we purchased cost as much as a small tractor, and like any other tool we have on our small farm, it must work for us.

Thus, we were cautious about making this purchase and, before we made any real investment, we decided to test the business application. The program we use to compile our index was originally written for a Wang minicomputer. We used this computer on a time-sharing basis, driving into town on weekends to input the information. Because we live some distance from town, each ride made the purchase of a home computer more attractive. We were further convinced when our mailbox started filling up with requests for the index. (To date, we've had 2,500 orders from individuals, bookstores, and book distributors—some coming from as far away as Australia.)

When we went "shopping" for a home computer, one of our considerations was the adaptability of the existing program to whatever home facility we could afford. Another obvious concern was our location. While Oregon's Applegate Valley, where we live, is not as remote as, say, Tibet, we are 150 miles from



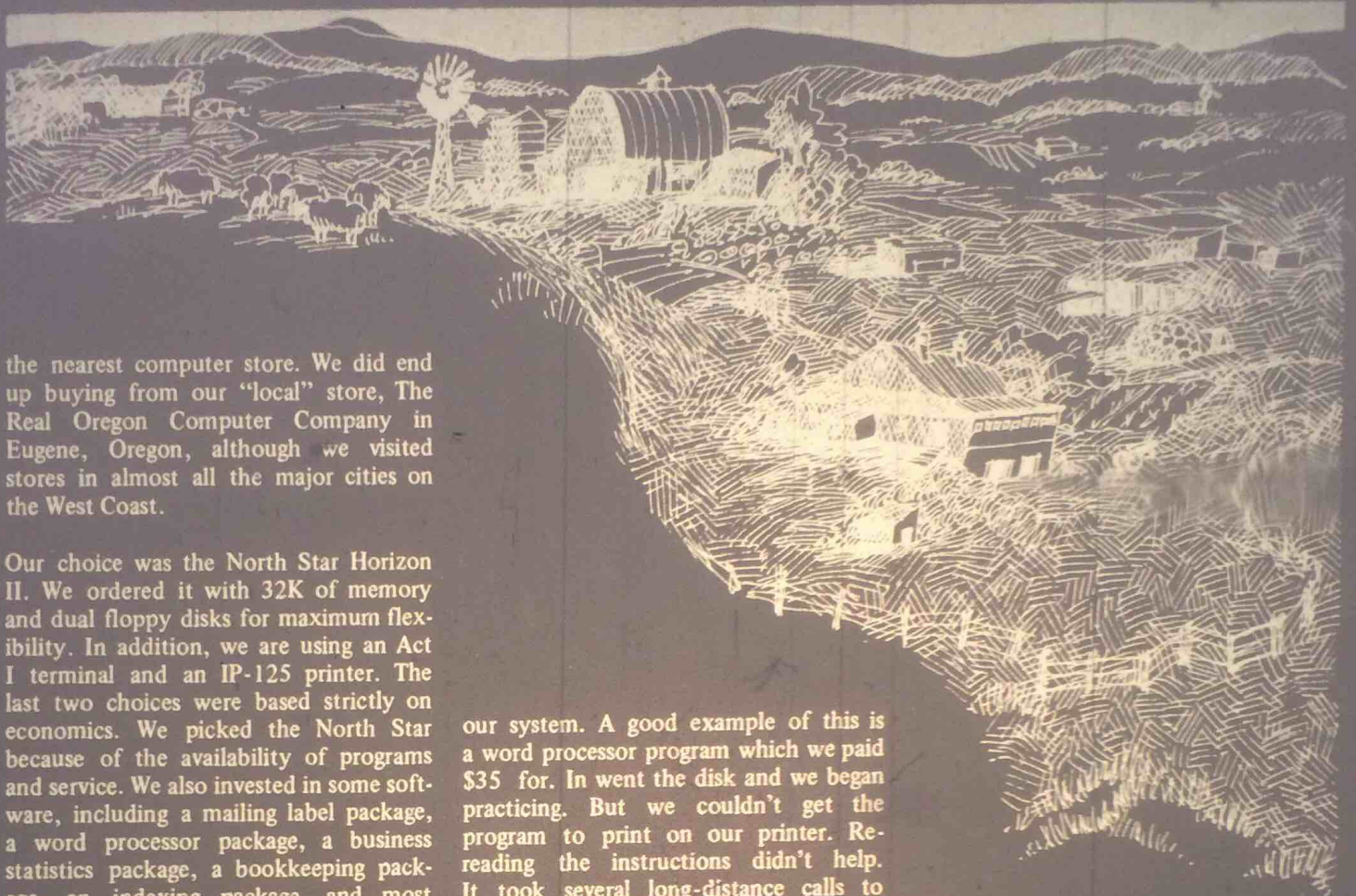

the nearest computer store. We did end up buying from our "local" store, The Real Oregon Computer Company in Eugene, Oregon, although we visited stores in almost all the major cities on the West Coast.

Our choice was the North Star Horizon II. We ordered it with 32K of memory and dual floppy disks for maximum flexibility. In addition, we are using an Act I terminal and an IP-125 printer. The last two choices were based strictly on economics. We picked the North Star because of the availability of programs and service. We also invested in some software, including a mailing label package, a word processor package, a business statistics package, a bookkeeping package, an indexing package, and most important, a tutorial program to educate us in using our computer correctly.

Since bringing our computer home, we've spent most of our time learning how to use the equipment. As we gain familiarity with it, we are realizing more clearly what some of our problems are. For instance, our choice of a microcomputer was based on the understanding that many companies sell software using North Star BASIC. Our assumption that these programs would fit any system using BASIC language was a mistake. We have discovered that most software is designed for general systems, and therefore we have had to struggle with adapting programs to our unit.

Because we are novices, this is a difficult process for us. In order to customize a program, we need to understand how the documentation is used. We must learn, to some extent, the vocabulary of programming language so we can translate and adjust programs to our use.

Every "canned" program we have purchased, or copied from magazines and books, has needed adjustment to fit

our system. A good example of this is a word processor program which we paid \$35 for. In went the disk and we began practicing. But we couldn't get the program to print on our printer. Re-reading the instructions didn't help. It took several long-distance calls to Eugene in order to solve the problem, which was to insert the proper code instructing our computer to send a message to the print board.

We've come to realize that the Tibetan monks I read about were able to put their computer to immediate use because they also imported expert technicians to assist them. We are not anxious to hire anyone and we are really not interested in becoming programmers ourselves! It's our hope that the industry will recognize the need for more efficient and simpler software packaging.

Despite our criticism, we are still enthusiastic about our home computer; it's already being used to keep business records and update our mailing list. And as soon as we complete the translation of the *Mother Earth* program to our computer, we'll move everything home (the index is still being done on the Wang in town—but not for much longer).

Once everything is in place here, we'll go on to figure out other ways to use our system. We're considering a multi-magazine index covering alternative energy

resources (shades of *The Whole Earth Catalog*!), a recipe index, and a record-keeping service for farm animal and crop production. Just possibilities now—but we want to develop products that will make the ownership of a home computer economically feasible.

As we enter our second year of production of the *Mother Earth* index, Applegate Computer Enterprises is definitely growing. ACE is housed, so far, in our bedroom and in an outbuilding we have on our property—and until a few months ago—consisted of me, my husband Rick, and our official stamp-licker, son Joshua, age 8. Now it includes Chris and Phil Hart. Chris is an art teacher at a local junior high school. Phil, Rick, and I all work at nearby Rogue Community College. I teach English, Rick is the director of computer and special services, and Phil is the community services director.

For all of us, one thing is certain—computers are no longer science fiction. □

# BUILDING A HI-RES SHAPE TABLE FOR THE APPLE II

BY CARL SWENSON

*O.K. Apple Fans, here's a way to create your favorite graphic shapes with a program submitted to us by Carl Swenson of Seattle, Washington. — CB*

A picture is worth a thousand words! Make smiley faces, monsters, starships, or store an X-Y coordinate system for graph plotting. Have fun using your imagination!

The Apple II has exciting high resolution graphic capabilities. One feature is a command, SHAPE, which will display a shape that has been stored in memory as a table. The trick, of course, is to create the table of your favorite shape and the following program does just that.

Transfer the figure or design to a transparency and tape it to the screen. Move the program's cursor with one of eight moves to trace out the shape. When finished CTRL-F will echo the shape stored as verification. The shape can be stored on tape or disk, ready to be added and used in any of your programs.

## PROGRAM DESCRIPTION

The program is initialized with a point cursor centered on the screen. Below the screen is displayed the move code, plot mode, and bytes used. There are eight move codes allowing the point to move to any adjacent point:



When the plot mode is OFF, the cursor moves without leaving the point plotted; it simply repositions the cursor. When

the plot mode is ON, the point is plotted and remains after the move is made. When you have finished the shape, or want to start over, type CTRL-F.

Suppose you want to reposition the cursor (plot mode OFF) and backtrack across some of the figure, thus unplotting part of what is shown on the screen. Never fear — any point once plotted will appear in the final figure. However, this has a drawback, since the plot mode OFF cannot be used to erase mistakes.

## PROGRAM USE

Load the program as you would any other program that used HI-RES graphics. If you are new to the world of HI-RES, then follow the instructions of the Apple II reference manual. Briefly they are:

- 1) Reset
- 2) \*C00.FFFR starts hires tape, hit RETURN
- 3) CTRL-B to get to BASIC
- 4) >HIMEM:8192, hit RETURN
- 5) type in the program

The shape table is started at 0900 which is high enough to avoid the variables table, and low enough to allow a more than 2000 byte table. Should you desire to have the table at another location, the monitor has a simple move memory command, or it is easily changed in the program itself. Program space can be saved by deleting the remarks.

## PROGRAM DOCUMENTATION

For those of you who would like to know how things work, here is a description of SHAPE, a variable list, and a line-by-line documentation:

Each byte of the shape table is divided into three sections, and each section specifies a direction to move (up, down, left, or right) and also whether or not to

plot the point before moving. The starting address of the table is stored in decimal memory location 804 and 805. The SHAPE subroutine steps through the vector table byte by byte, and then through each byte section by section, with sections processed right to left. When it reaches a 00 byte, that signals the end of the table.

The three sections are arranged in a byte as shown below:

7	6	5	4	3	2	1	0
D	D	P	D	D	P	D	D
Section 1			Section 2		Section 3		
MOVES				DD CODE			
↑				00			
→				01			
↓				10			
←				11			

Each bit pair DD specifies a direction to move, and the bit P specifies whether or not to plot the point before moving. Section 3 (most significant bits) does not have a P field, so it can only be a move without plotting. If the section 3 is 00, it is ignored, thus section 3 can never be a move with plotting or a move up without plotting.

## Variable List

B . . . . . complete byte (3 sections) or move code  
 BYTE. . . . . count of bytes used in table  
 C( ). . . . . stores move codes waiting for complete byte  
 KEY . . . . . value of key pressed  
 LOC . . . . . location in shape table  
 N . . . . . number of unstored move codes  
 OLDX . . . . . old X coordinate  
 OLDY . . . . . old Y coordinate  
 PFLAG. . . . . plot mode status (1 = ON, 0 = OFF)  
 SAVE. . . . . saves extra move code for next byte  
 X . . . . . new X coordinate  
 Y . . . . . new Y coordinate



### SPECIAL NOTE TO APPLESOFT II USERS

The program is written in Integer BASIC and now the more powerful Applesoft II is available. To use any shape table (or any combination of them) requires only the addition of a simple index at the start of the table. The table starting address must also be stored in \$E8 and \$E9.

For example, suppose you have used the Integer BASIC program to create a shape table starting at 2304 (\$0900). Since there is only one shape, a 1 is placed in the first byte of the index. This byte tells how many shapes one stored in the total table. Secondly, the number of bytes from the table beginning to the first shape beginning (4 in this case) is stored in byte 3 and 4. A second shape would use byte

5 and 6, etc. In our simple case here the index can be built directly with the following commands in either BASIC:

```
POKE 2300,1
POKE 2301,0
POKE 2302,4
POKE 2303,0
```

The table address with the index added is now 2300(\$08FC) and can be loaded into \$E8 and \$E9 with:

```
POKE 232,252
POKE 233,8
```

These could be added to the program so that it is done automatically. Consult your Applesoft II documentation for a thorough treatment of the manipulation of shape tables. The Applesoft II features will allow you to simplify the program if you use it exclusively in Applesoft II. A word of warning: Be sure SCALE=1.

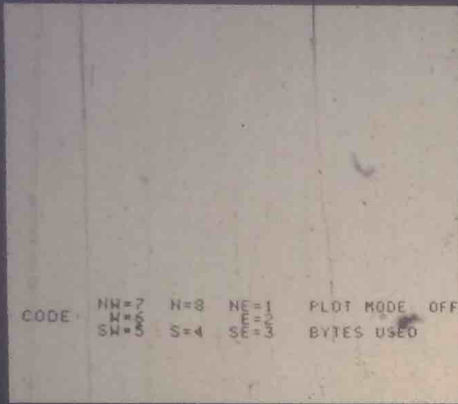

Figure 1. When the program is run the screen will initially look like this. Notice the plot point in the center of the screen. Plot mode is off.

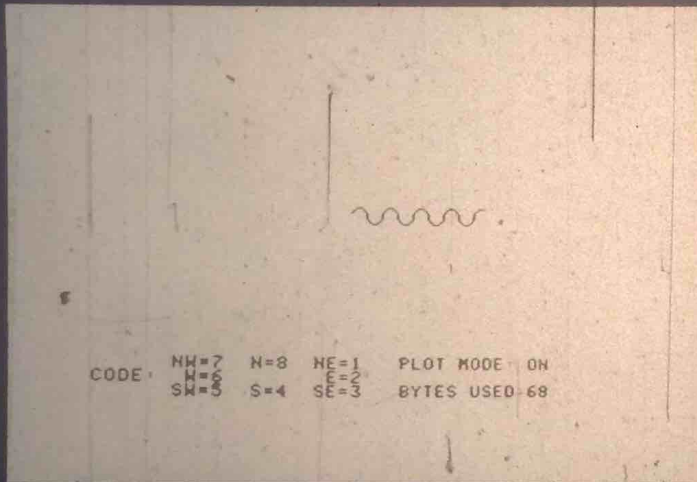

Figure 2. The plot mode has been turned on and a shape created.

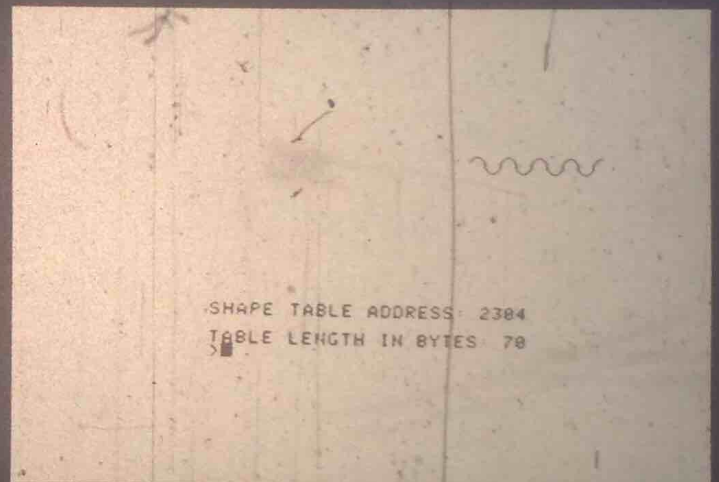

Figure 3. CTRL-F has been hit to complete the table. The table address and length are shown and ready to be used to save the shape table if desired.

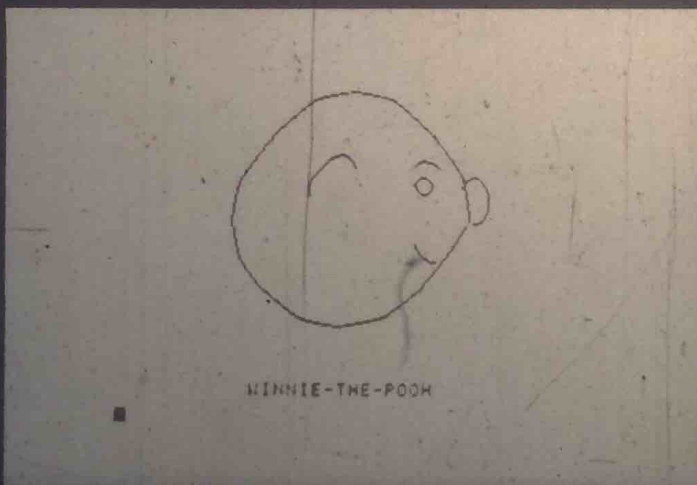

Figure 4. The author's hero. This shape was stored and called back in a program.

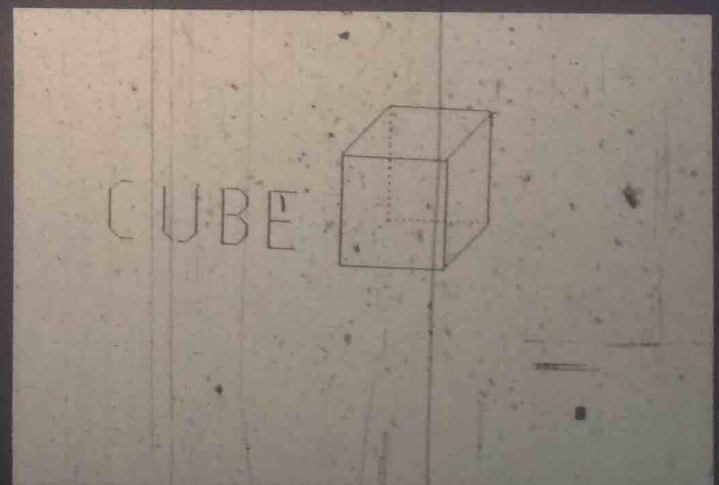

Figure 5. Shape builder allows making figures with dotted lines. It also allows word and letter formation.

```

>LIST
110 REM ***** HIRES SHAPE BUILDER *****
120 REM (7-21-78) CARL SWENSON
125 REM -----INITIALIZE-----
130 DIM C(3):C(1)=0:C(2)=0:C(3)=0
140 INIT=3072:PLOT=3780:POSN=3761:SHAPE=3805
150 LOC=2304:X=139:Y=79
160 CALL INIT: POKE 812,255:N=0:C(0)=8: GOSUB 550
170 VTAB 22: PRINT " NE=7 N=8 NW=1 PLOT MODE: OFF"
180 VTAB 23: PRINT "CODE: E=6 W=2"
190 VTAB 24: PRINT " SE=5 S=4 SW=3 BYTES USED:"
195 REM -----KEYBOARD TEST -----
200 POKE -16368,0
210 KEY= PEEK (-16384): IF KEY<128 THEN 210:KEY=KEY-176
220 IF KEY=-42 THEN 420: IF KEY=1 OR KEY=7 OR KEY=8 THEN 300
230 IF KEY>2 AND KEY<6 THEN 330: IF KEY=2 THEN 360
240 IF KEY=6 THEN 390: IF KEY#32 THEN 200
245 REM -----CHANGE PLOT MOLE-----
250 PFLAG= NOT PFLAG
260 VTAB 21: TAB 36: IF PFLAG=0 THEN 280
270 PRINT "ON "; GOTO 200
280 PRINT "OFF"
290 GOTO 200
295 REM -----KEY 1,7,8 -----
300 IF OLDY=0 THEN 200:Y=OLDY-1
310 C(N)=0: IF PFLAG=1 THEN C(N)=4: GOSUB 550
320 IF KEY=7 THEN 390: IF KEY=1 THEN 360: GOTO 200
325 REM -----KEY 3,4,5 -----
330 IF OLDY=159 THEN 200:Y=OLDY+1
340 C(N)=2: IF PFLAG=1 THEN C(N)=6: OSUB 550
350 IF KEY=5 THEN 390: IF KEY=3 THEN 360: GOTO 200
355 REM -----KEY 2 -----
360 IF OLDX=279 THEN 200:X=OLDX+1
370 C(N)=1: IF PFLAG=1 AND KEY=2 THEN C(N)=5
380 GOSUB 550: GOTO 200
385 REM -----KEY 6 -----
390 IF OLDX=0 THEN 200:X=OLDX-1
400 C(N)=3: IF PFLAG=1 AND KEY=6 THEN C(N)=7
410 GOSUB 550: GOTO 200
415 REM -----CTRL F SHAPE FINISHED-----
420 CALL -936
430 B=C(1)+C(2)*8+C(3)*64: POKE LOC,B
440 IF B=0 AND BYTE>0 THEN 460
450 LOC=LOC+1: POKE LOC,0:BYTE=BYTE+1
460 VTAB 22: PRINT "SHAPE TABLE ADDRESS: 0900"
470 VTAB 24: PRINT "TABLE LENGTH IN BYTES: ";BYTE+1;
475 REM -----ECHO SHAPE TABLE -----
480 CALL INIT
490 POKE 802,79: POKE 801,0: POKE 800,139: CALL POSN
500 LOC=LOC-BYTE
510 POKE 805,LOC/256: POKE 804,LOC MOD 256
520 POKE 812,255: POKE 807,0: POKE 806,1
530 CALL SHAPE
540 GOTO 720
545 REM -----SUBROUTINE POINT PLOT-----
550 IF C(N)>3 THEN 580
560 POKE 802,OLDY: POKE 801,OLDX/256: POKE 800,OLDX MOD 256
570 POKE 812,0: CALL PLOT
580 POKE 802,Y: POKE 801,X/256: POKE 800,X MOD 256
590 POKE 812,255: CALL PLOT
600 IF N>2 THEN GOSUB 620
610 N=N+1:OLDX=X:OLDY=Y: RETURN
615 REM -----SUBROUTINE TO STORE COMPLETE BYTES -----
620 IF C(3)<4 THEN 640
630 SAVE=C(3):C(3)=0
640 B=C(1)+C(2)*8+C(3)*64
650 IF B#0 THEN 670: REM ----PATCH DOUBLE NO PLOT UPS
660 B=128: POKE LOC,B:LOC=LOC+1:BYTE=BYTE+1
670 POKE LOC,B:LOC=LOC+1
680 BYTE=BYTE+1: VTAB 23: TAB 36: PRINT BYTE
690 IF C(3)=0 THEN 710
700 C(1)=0:C(2)=0:C(3)=0:SAVE=0:N=0: RETURN
710 C(1)=SAVE:C(2)=0:C(3)=0:SAVE=0:N=1: RETURN
720 END

```

set graphic mode and plot cursor  
print text below screen

clear keyboard

loop to test key: if hit, subtract 176 to create value 1 to 8.  
branch to finish table if -42, move up if 1, 7, 8; move down  
if 3, 4, 5; move right if 2; move left if 4; switch plot  
mode if 32, clear keyboard if none of above.

switch plot mode, print status

check boundary: if OK, move up  
set code for table: subroutine plot and store  
branch to second move if diagonal, else clear keyboard

same as 300-230 except move down

check boundary: if OK, move right  
set code for table (diagonal moves not plotted)  
subroutine plot and store: clear keyboard

same as 360-380 except move left

clear text  
unstored moves to table, endmark zero, updat. count

print address & length

graphic mode  
position shape to center  
set start address of table

with no rotation or scale factor call shape

end

leave old point plotted if coded for plot

plot new point

if three codes store them  
update and return

if C(3) in plot mode then byte created with two codes and  
third saved for next byte

put in dummy move to separate two up moves that would  
create end of table signal  
store byte: increment table location  
update and print number of bytes  
initialize move code array and count: put saved move in  
next byte



# An Electronic Desk Calendar

BY CLYDE FARRELL

*Clyde Farrell returns again this issue with an applications routine for the 16K TRS-80. Clyde, a frequent contributor, presents an initial effort in the area of what he terms "personal applications": an Electronic Desk Calendar. The EDC can store forty 240 character messages that are automatically retrieved and displayed on the TRS-80. He also has a modified version for DISK BASIC.*

*Information on the disk version of EDC and on the wealth of other TRS-80 BASIC programs that Clyde has produced can be obtained by writing:*

Farrell Enterprises  
P.O. Box 4392  
Walnut Creek, CA 94596

- RZ

ENTER TODAY'S DATE (MONTH, DAY, YEAR)? 10, 6, 78  
IS TODAY FRIDAY? YES

It has been over a year now from the time the TRS-80 was announced, and since then, many a TRS-80 has rolled off the assembly line and fallen into the hands of waiting consumers such as myself. A source of fascination to all of us in the beginning, it evolved quickly into a new mode of entertainment as the proliferation of games now available will testify. For many, this was the real reason for buying a computer (oh sure, you all said you would balance your checkbooks and maintain tax records but come on now, tell the truth). That reason was (and still is) a good one, and this demand for amusements should keep many a programmer's creative juices flowing in

order to supply refreshing new games to a diversion thirsty world. When the games are over, though, in how many ways is *your* computer helping you?

I have yet to go into a computer store and buy a book of "personal applications" programs. This tells me something. When somebody asks me, "But what can you *do* with a home computer?", I sometimes tend to draw a blank. There seems to be a real software void in the area of practical, personal application programs. The Electronic Desk Calendar is an initial attempt to start filling that void.

DATE MESSAGE ENTERED: 10/5/1978

DATE TO BE REMINDED: 10/5/1978

MESSAGE: DENTAL APPOINTMENT 4PM

NEED THIS MESSAGE ANY LONGER? \_\_\_\_\_

EDC is written for the TRS-80 in Level II Basic. It allows you to make notes to yourself and be reminded automatically on the requested date. In addition, EDC will continue to remind you every day after that until you no longer need the message. As a side benefit, EDC can tell you the day of the week for any date between the year 1583 and the next calendar revision. The notes and messages are stored on a cassette data tape which is recirculated through the program on a daily (or whenever) basis. EDC also has some other potentials which could be realized through minor modification.



DATE MESSAGE ENTERED: 10/5/1978

DATE TO BE REMINDED: 10/6/1979

MESSAGE: MEET THE DRAGON - LUNCH 2 PM  
NEED THIS MESSAGE ANY LONGER? \_

A small change in EDC would allow a person to be notified of an event that occurs annually (birthdays, anniversaries, insurance renewals) or even monthly (credit card due dates). These events could be saved on a special cassette, and the program could be run whenever necessary.

EDC could also be incorporated into other programs to help small businesses. An example might be an insurance company that needs to know when to send renewal notices, PR letters, or be notified when a potential customer's policy with a different company is about to expire. A file of customers or potential customers could be passed through EDC with the proper correspondence generated for each case.

DATE MESSAGE ENTERED: 10/5/1978

DATE TO BE REMINDED: 10/6/1978

MESSAGE: PIANO BAR SAFARI 9 PM  
NEED THIS MESSAGE ANY LONGER? \_

EDC is a practical and useful tool for both business and personal applications. It will help to fill the void in this area, but it is only a beginning. The more of this type of program there is, the less we need to answer that question of what can be done with a home computer with, "I don't know."

```
1295 PRINT"POSITION TAPE PAST THE LEADER"  
1300 PRINT"AND PRESS BOTH 'RECORD' AND 'PLAY'" :PRINT  
1310 INPUT"PRESS ENTER WHEN YOU'RE READY";YMS  
1320 PRINT#-L;"MESSAGE TAPE"  
1330 PRINT#-L;RL  
1340 FOR I=1 TO 1  
1342 CLS:PRINT#56;"WRITING TAPE";PRINT#-L+L;"RECORDS MORE"  
1350 PRINT#-L;R0(C),R1(C),R2(C),R3(C),R4(C),R5(C),R6(C),R7(C),R8(C)  
1360 NEXT:CLS  
1370 PRINT"THAT'S ALL FOR TODAY":END  
3000 'DAY OF THE WEEK  
3100 IFND2 THEN G3130  
3110 TM=TM+12  
3120 TY=TY-1  
3130 N=TD+2*(TM+1)+TY+INT(TY/4)-INT(TY/100)+INT(TY/400)*2  
3140 N=INT((N/7)-INT(N/7))*7+5)  
3150 IFND8 THEN G3180  
3160 D4="SATURDAY"  
3170 GOTO G3130  
3180 IFND1 THEN G3210  
3190 D4="SUNDAY"  
3200 GOTO G3130  
3210 IFND2 THEN G3240  
3220 D4="MONDAY"  
3230 GOTO G3130  
3240 IFND3 THEN G3270  
3250 D4="TUESDAY"  
3260 GOTO G3130  
3270 IFND4 THEN G3300  
3280 D4="WEDNESDAY"  
3290 GOTO G3130  
3300 IFND5 THEN G3330  
3310 D4="THURSDAY"  
3320 GOTO G3130  
3330 D4="FRIDAY"  
3340 RETURN  
5000 CLS:PRINT"DATE MESSAGE ENTERED: ";  
5010 PRINT#(C);"/";R0(C);"/";R1(C):PRINT:PRINT  
5020 PRINT"DATE TO BE REMINDED: ";  
5030 PRINT#(C);"/";R0(C);"/";R1(C):PRINT:PRINT  
5040 PRINT"MESSAGE: ";R2(C):PRINT:YMS=""  
5050 INPUT"NEED THIS MESSAGE ANY LONGER";YMS  
5060 IF LEFT$(YMS,1)="" THEN R2(C)=""  
5070 RETURN
```

Day-of-week subroutine.

Create the new message tape.

# In the Year 2889



BY JULES VERNE

*For most sci-fi predictions, the results aren't yet in. But for the work of Jules Verne, sci-fi's founding father, we already have the verdict: it was uncannily prophetic. Take, for instance, the story below, which talks of air cars and telephony (television), computers and Electro-Reckoners. Verne erred only in anticipating how soon his scenarios would come true; many occurred within decades of his death.*

*Long fascinated with things American, Frenchman Verne set this story in the U.S. capital, Centropolis, in the year 2889. It was written for an American audience and first appeared in the New York Forum magazine 90 years ago. What follows is a slightly abridged version of that piece. Our thanks to Claude Kagan for uncovering this little known relic of Verne-abilia.*

—LB

Little though they seem to think of it, the people of this twenty-ninth century live continually in fairyland. Surfeited as they are with marvels, they are indifferent in the presence of each new marvel. To them all seems natural. Could they but duly appreciate the refinements of civilization in our day; could they but compare the present with the past, and so better comprehend the advance we have made! How much fairer they would find our modern towns, with populations amounting sometimes to 10,000,000 souls; their streets 300 feet wide, their houses 1000 feet in height; with a temperature the same in all seasons; with their lines of aerial locomotion crossing the sky in every direction! If they would but picture to themselves the state of things that once existed, when through muddy streets rumbling boxes on wheels, drawn by horses—yes, by horses!—were the only means of conveyance. Think of the railroads of the olden time, and you will be able to appreciate the pneumatic tubes through which today one travels at the rate of 1000 miles an hour. Would not our contemporaries prize the telephone and the telephoto more highly if they had not forgotten the telegraph?

Singularly enough, all these transformations rest upon principles which were perfectly familiar to our remote ancestors,

but which they disregarded. Heat, for instance, is as ancient as man himself; electricity was known 3000 years ago, and steam 1100 years ago. Nay, so early as ten centuries ago it was known that the differences between the several chemical and physical forces depend on the mode of vibration of the etheric particles, which is for each specifically different. When at last the kinship of all these forces was discovered, it is simply astounding that 500 years should still have to elapse before men could analyze and describe the several modes of vibration that constitute these differences. Above all, it is singular that the mode of reproducing these forces directly from one another, and of reproducing one without the others, should have remained undiscovered till less than a hundred years ago. Nevertheless, such is the course of events, for it was not till the year 2792 that the famous Oswald Nier made this great discovery.

Truly was he a great benefactor of the human race. His admirable discovery led to many another. Hence is sprung a pleiad of inventors, its brightest star being our great Joseph Jackson. To Jackson we are indebted for those wonderful instruments, the new accumulators. Some of these absorb and condense the living force contained in the sun's rays; others, the electricity stored in our globe; others again, the energy coming from whatever source, as a waterfall, a stream, the winds, etc. He, too, it was that invented the transformer, a more wonderful contrivance still, which takes the living force from the accumulator, and, on the simple pressure of a button, gives it back to space in whatever form may be desired, whether as heat, light, electricity, or mechanical force, after having first obtained from it the work required. From the day when these two instruments were contrived is to be dated the era of true progress. They have put into the hands of man a power that is almost infinite. As for their applications, they are numberless. Mitigating the rigors of winter, by giving back to the atmosphere the surplus heat stored up during the summer, they have revolutionized agriculture. By supplying motive power for aerial navigation, they have given to commerce a mighty impetus. To them we



# Dr. Dobb's Journal

of Computer Calisthenics & Orthodontia

## SUBSCRIPTION ORDER

Please start my one-year subscription to *Dr. Dobb's Journal* (published ten times a year) for \$15.

NAME \_\_\_\_\_

ADDRESS \_\_\_\_\_

CITY/STATE \_\_\_\_\_ ZIP \_\_\_\_\_

Check enclosed     Bill me     Renewal (please attach mailing label.)

Charge my card:     Visa/Bankamericard     Mastercharge  
Card No. \_\_\_\_\_ Exp. Date \_\_\_\_\_

Signature \_\_\_\_\_

International Rates: Canada *First Class*  \$25 one year

Rest of World *Airmail*  \$33 one year

*World Surface Mail* — I will risk the lengthy and unreliable delivery of surface mail (signed) \_\_\_\_\_  \$20 one year

Payment must be in \$US drawn on a US bank.

Exp. Date: June 1, 1979

3Y

**FIRST CLASS  
PERMIT NO. 756  
MENLO PARK, CA**

---

# **BUSINESS REPLY MAIL**

**No postage stamp necessary if mailed in the United States**

---

Postage will be paid by

**Recreational Computing  
P.O. Box E  
Menlo Park, California 94025**

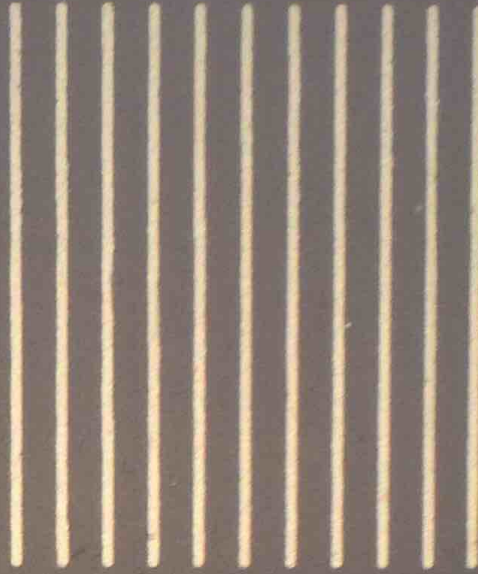

are indebted for the continuous production of electricity without batteries or dynamos, of light without combustion or incandescence, and for an unending supply of mechanical energy for all the needs of industry.

Yes, all these wonders have been wrought by the accumulator and the transformer. And can we not to them also trace, indirectly, this latest wonder of all, the great "Earth Chronicle" building on 253rd Avenue, which was dedicated the other day? If George Washington Smith, the founder of the Manhattan "Chronicle," should come back to life to-day, what would he think were he to be told that this palace of marble and gold belongs to his remote descendant, Fritz Napoleon Smith, who, after thirty generations have come and gone, is owner of the same newspaper which his ancestor established!

For George Washington Smith's newspaper has lived generation after generation, now passing out of the family, anon coming back to it. When, 200 years ago, the political center of the United States was transferred from Washington to Centropolis, the newspaper followed the government and assumed the name of Earth Chronicle. Unfortunately, it was unable to maintain itself at the high level of its name. Pressed on all sides by rival journals of a more modern type, it was continually in danger of collapse. Twenty years ago its subscription list contained but a few hundred thousand names, and then Mr. Fritz Napoleon Smith bought it for a mere trifle, and originated telephonic journalism.

Everyone is familiar with Fritz Napoleon Smith's system—a system made possible by the enormous development of telephony during the last hundred years. Instead of being printed, the Earth Chronicle is every morning spoken to subscribers, who, in interesting conversations with reporters, statesmen, and scientists, learn the news of the day. Furthermore, each subscriber owns a phonograph, and to this instrument he leaves the task of gathering the news whenever he happens not to be in a mood to listen directly himself. As for purchasers of single copies, they can at a very trifling cost learn all that is in the paper of the day at any of the innumerable phonographs set up nearly everywhere.

Fritz Napoleon Smith's innovation galvanized the old newspaper. In the course of a few years the number of subscribers grew to be 85,000,000, and Smith's wealth went on growing, till now it reaches the almost unimaginable figure of \$10,000,000,000. His mode of life may well astonish one. Fritz Napoleon Smith's iron constitution is taxed to the utmost by the heavy strain that is put upon it. Vain the attempt to estimate the amount of labor he undergoes; an example alone can give an idea of it. Let us then go about with him for one day as he attends to his multifarious concerns. What day? That matters little; it is the same every day. Let us then take at random September 25th of this present year 2889.

This morning Mr. Fritz Napoleon Smith awoke in very bad humor. His wife having left for France eight days ago, he was feeling disconsolate. Incredible though it seems, in all the ten years since their marriage, this is the first time that Mrs. Edith Smith, the professional beauty, has been so long absent from home; two or three days usually suffice for her frequent

.....

'To Jackson we are indebted for those wonderful instruments, the new accumulators. Some of these absorb and condense the living force contained in the sun's rays; others, the electricity stored in our globe; others again, the energy coming from whatever source, as a waterfall, a stream, the winds . . .'

.....

trips to Europe. The first thing that Mr. Smith does is to connect his phonotelephone, the wires of which communicate with his Paris mansion. The telephote! Here is another of the great triumphs of science in our time. The transmission of speech is an old story; the transmission of images by means of sensitive mirrors connected by wires is a thing but of yesterday. A valuable invention indeed, and Mr. Smith this morning was not niggard of blessings for the inventor, when by its aid he was able distinctly to see his wife notwithstanding the distance that separated him from her. Mrs. Smith, weary after the ball or the visit to the theater the preceding night, is still abed, though it is near noontide at Paris. She is asleep, her head sunk in the lace-covered pillows. What? She stirs? Her lips move. She is dreaming perhaps? Yes, dreaming. She is talking, pronouncing a name—his name—Fritz! The delightful vision gave a happier turn to Mr. Smith's thoughts. And now, at the call of imperative duty, light-hearted he springs from his bed and enters his mechanical dresser.

Two minutes later the machine deposited him all dressed at the threshold of his office. The round of journalistic work was now begun. First he enters the hall of the novel-writers, a vast apartment crowned with an enormous transparent cupola. In one corner is a telephone, through which a hundred Earth Chronicle *littérateurs* in turn recount to the public in daily installments a hundred novels. Addressing one of these authors who was waiting his turn, "Capital! Capital! my dear fellow," said he, "your last story. The scene where the village maid discusses interesting philosophical problems with her lover shows your very acute power of observation. Never have the ways of country folk been better portrayed. Keep on, my dear Archibald, keep on! Since yesterday, thanks to you, there is a gain of 5000 subscribers."

"Mr. John Last," he began again, turning to a new arrival, "I am not so well pleased with your work. Your story is not a picture of life; it lacks the elements of truth. And why? Simply because you run straight on to the end; because you do not analyze. Your heroes do this thing or that from this or that motive, which you assign without ever a thought of dissecting their mental and moral natures. Our feelings, you must remember, are far more complex than all that. In real life every act is the resultant of a hundred thoughts that come and go, and these you must study, each by itself, if you would

create a living character. 'But,' you will say, 'in order to note these fleeting thoughts one must know them, must be able to follow them in their capricious meanderings.' Why, any child can do that, as you know. You have simply to make use of hypnotism, electrical or human; which gives one a two-fold being, setting free the witness-personality so that it may see, understand, and remember the reasons which determine the personality that acts. Just study yourself as you live from day to day, my dear Last. Imitate your associate whom I was complimenting a moment ago. Let yourself be hypnotized. What's that? You have tried it already? Not sufficiently, then, not sufficiently!"

**'Furthermore, each subscriber owns a phonograph, and to this instrument he leaves the task of gathering the news whenever he happens not to be in a mood to listen directly himself.'**

Mr. Smith continues his round and enters the reporters' hall. Here 1500 reporters, in their respective places, facing an equal number of telephones, are communicating to the subscribers the news of the world as gathered during the night. The organization of this matchless service has often been described. Besides his telephone, each reporter, as the reader is aware, has in front of him a set of commutators, which enable him to communicate with any desired telephotic line. Thus the subscribers not only hear the news but see the occurrences. When an incident is described that is already past, photographs of its main features are transmitted with the narrative. And there is not confusion withal. The reporters' items, just like the different stories and all the other component parts of the journal, are classified automatically according to an ingenious system, and reach the hearer in due succession. Furthermore, the hearers are free to listen only to what specially concerns them. They may at pleasure give attention to one editor and refuse it to another.

Mr. Smith next addresses one of the ten reporters in the astronomical department—a department still in the embryonic stage, but which will yet play an important part in journalism.

"Well, Cash, what's the news?"

"We have phototelegrams from Mercury, Venus, and Mars."

"Are those from Mars of any interest?"

"Yes, indeed. There is a revolution in the Central Empire."

"And what of Jupiter?" asked Mr. Smith.

"Nothing as yet. We cannot quite understand their signals. Perhaps ours do not reach them."

"That's bad," exclaimed Mr. Smith as he hurried away, not in the best of humor, toward the hall of the scientific editors. With their heads bent down over their electric computers, thirty scientific men were absorbed in transcendental calculations. The coming of Mr. Smith was like the falling of a bomb among them.

"Well, gentlemen, what is this I hear? No answer from Jupiter? Is it always to be thus? Come, Cooley, you have been at work now twenty years on this problem, and yet—"

"True enough," replied the man addressed. "Our science of optics is still very defective, and though our mile-and-three-quarter telescopes—"

"Listen to that, Peer," broke in Mr. Smith, turning to a second scientist. "Optical science defective! Optical science is your specialty. But," he continued, again addressing William Cooley, "failing with Jupiter, are we getting any results from the moon?"

"The case is not better there."

"This time you do not lay the blame on the science of optics. The moon is immeasurably less distant than Mars, yet with Mars our communication is fully established. I presume you will not say that you lack telescopes?"

"That's it," added Peer.

"So, then, the moon is positively uninhabited?" asked Mr. Smith.

"At least," answered Cooley, "on the face which she presents to us. As for the opposite side, who knows?"

"Ah, the opposite side! You think, then," remarked Mr. Smith, musingly, "that if one could but—"

"Could what?"

"Why, turn the moon about-face."



"Ah, there's something to that," cried the two men at once. And indeed, so confident was their air, they seemed to have no doubt as to the possibility of success in such an undertaking.

"Meanwhile," asked Mr. Smith, after a moment's silence, "have you no news of interest to-day?"

"Indeed we have," answered Cooley. "The elements of Olympus are definitively settled. That great planet gravitates beyond Neptune at the mean distance of 11,400,799,642 miles from the sun, and to traverse its vast orbit takes 1311 years, 294 days, 12 hours, 43 minutes, 9 seconds."

"Why didn't you tell me that sooner?" cried Mr. Smith. "Now inform the reporters of this straightway. You know how eager is the curiosity of the public with regard to these astronomical questions. That news must go into today's issue."

Mr. Smith's daily tour through the several departments of his newspaper is now finished. Next, he passes to the reception chamber, where the ambassadors accredited to the American government are awaiting him, desirous of having a word of counsel or advice from the all-powerful editor. A discussion was going on when he entered. "Your Excellency will pardon me," the French Ambassador was saying to the Russian, "but I see nothing in the map of Europe that requires change. 'The North for the Slavs?' Why, yes, of course; but the South for the Latins. Our common frontier, the Rhine, it seems to me, serves very well. Besides, my government, as you must know, will firmly oppose every movement, not only against Paris, our capital, or our two great prefectures, Rome and Madrid, but also against the kingdom of Jerusalem, the domination of Saint Peter, of which France means to be the trusty defender."

"Well said!" exclaimed Mr. Smith. "How is it," he asked, turning to the Russian ambassador, "that you Russians are not content with your vast empire, the most extensive in the world, stretching from the banks of the Rhine to the Celestial Mountains and the Kara-Korum, whose shores are washed by

the Frozen Ocean, the Atlantic, the Mediterranean, and the Indian Ocean? Then, what is the use of threats? Is war possible in view of modern inventions—*asphyxiating shells capable of being projected a distance of 60 miles, an electric spark of 90 miles, that can at one stroke annihilate a battalion; to say nothing of the plague, the cholera, the yellow fever that the belligerents might spread among their antagonists mutually, and which would in a few days destroy the greatest armies?*"

"True," answered the Russian; "but can we do all that we wish? As for us Russians, pressed on our eastern frontier by the Chinese, we must at any cost put forth our strength for an effort toward the west."

**'With their heads bent down over their electric computers, thirty scientific men were absorbed in transcendental calculations. The coming of Mr. Smith was like the falling of a bomb among them.'**

"O, is that all? In that case," said Mr. Smith, "the thing can be arranged. I will speak to the Secretary of State about it. The attention of the Chinese government shall be called to the matter. This is not the first time that the Chinese have bothered us."

"Under these conditions, of course—" And the Russian ambassador declared himself satisfied.

"Ah, Sir John, what can I do for you?" asked Mr. Smith as he turned to the representative of the people of Great Britain, who till now had remained silent.

"A great deal," was the reply. "If the Earth Chronicle would but open a campaign on our behalf—"

"And for what object?"

"Simply for the annulment of the Act of Congress annexing to the United States the British islands."

Though, by a just turn-about of things here below, Great Britain has become a colony of the United States, the English are not yet reconciled to the situation. At regular intervals they are ever addressing to the American government vain complaints.

"A campaign against the annexation that has been an accomplished fact for 150 years!" exclaimed Mr. Smith. "How can your people suppose that I would do anything so unpatriotic?"

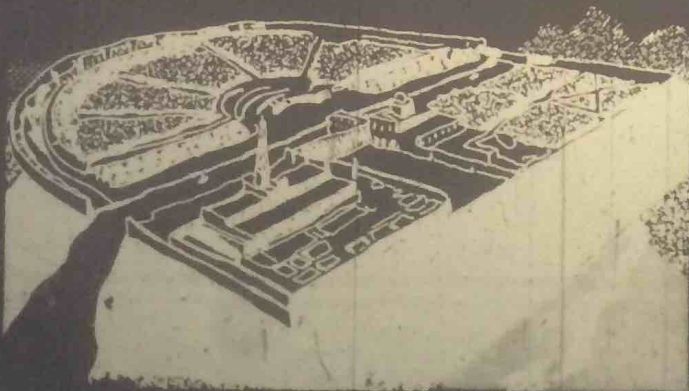

"We at home think that your people must now be sated. The Monroe doctrine is fully applied; the whole of America belongs to the Americans. What more do you want? Besides, we will pay for what we ask."

"Indeed!" answered Mr. Smith, without manifesting the slightest irritation. "Well, you English will ever be the same. No, no, Sir John, do not count on me for help."

The clock was striking twelve, the hour of breakfast. Mr. Smith returns to his chamber. Where the bed stood in the morning a table all spread comes up through the floor. For Mr. Smith, being above all a practical man, has reduced the problem of existence to its simplest terms. For him, instead of the endless suites of apartments of the olden time, one room fitted with ingenious mechanical contrivances is enough. Here he sleeps, takes his meals, in short, lives.

Like all wealthy folk in our day, Mr. Smith has done away with the domestic kitchen and is a subscriber to the Grand

**'Like all wealthy folk in our day,  
Mr. Smith has done away with the  
domestic kitchen and is a subscriber  
to the Grand Alimentation Company,  
which sends through a great network  
of tubes to subscribers' residences  
all sorts of dishes, as a varied  
assortment is always in readiness.'**

Alimentation Company, which sends through a great network of tubes to subscribers' residences all sorts of dishes, as a varied assortment is always in readiness. A subscription costs money, to be sure, but the *cuisine* is of the best, and the system has this advantage, that it does away with the pestering race of the *cordons-bleus*. Mr. Smith received and ate, all alone, the *hors-d'oeuvre*, *entrées*, *rôti*, and *legumes* that constituted the repast. He was just finishing the dessert when Mrs. Smith appeared in the mirror of the telephoto.

"Why, where have you been?" asked Mr. Smith through the telephone.

"What! You are already at the dessert? Then I am late," she exclaimed, with a winsome *naïveté*. "I suppose I forgot to note the time, and so am a little late."

"Yes, a little," growled Mr. Smith; "so little that I have already quite finished breakfast. Excuse me if I leave you now, but I must be going."

"O certainly, my dear; good-by till evening."

Smith stepped into his air-coach, which was in waiting for him at a window. "Where do you wish to go, sir?" inquired the coachman.



"Let me see; I have three hours," Mr. Smith mused. "Jack, take me to my accumulator works at Niagara."

For Mr. Smith has obtained a lease of the great falls of Niagara. For ages the energy developed by the falls went unutilized. Smith, applying Jackson's invention, now collects this energy, and lets or sells it. His visit to the works took more time than he had anticipated. It was four o'clock when he returned home, just in time for the daily audience which he grants to callers.

One readily understands how a man situated as Smith is must be beset with requests of all kinds. Now it is an inventor needing capital; again it is some visionary who comes to advocate a brilliant scheme which must surely yield millions of profit. A choice has to be made between these projects, rejecting the worthless, examining the questionable ones, accepting the meritorious.

The callers were fewer today than usual—only twelve of them. Of these, eight had only impracticable schemes to propose. Of the four projects favorably received, the first was that of a young man whose broad forehead betokened his intellectual power.

"Sir, I am a chemist," he began, "and as such I come to you."

"Well!"

"Once the elementary bodies," said the young chemist, "were held to be sixty-two in number; a hundred years ago they were reduced to ten; now only three remain irresolvable, as you are aware."

"Yes, yes."

"Well, sir, these also I will show to be composite. In a few months, a few weeks, I shall have succeeded in solving the problem. Indeed, it may take only a few days."

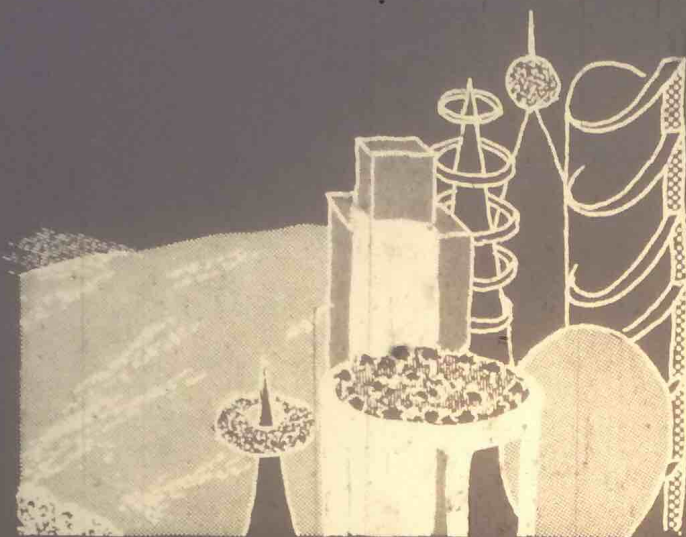

a vast territory available for man's use. What think you of the scheme?"

"Leave your plans with me, and come back in a week. I will have them examined in the meantime."

Finally, the fourth announced the early solution of a weighty scientific problem. Every one will remember the bold experiment made a hundred years ago by Dr. Nathaniel Faithburn. The doctor, being a firm believer in human hibernation—in other words, in the possibility of our suspending our vital functions and of calling them into action again after a time—resolved to subject the theory to a practical test. To this end, having first made his last will and pointed out the proper method of awakening him; having also directed that his sleep was to continue a hundred years to a day from the date of his apparent death, he unhesitatingly put the theory to the proof in his own person. Reduced to the condition of a mummy, Dr. Faithburn was confined and laid in a tomb. Time went on. September 25th, 2889, being the day set for his resurrection, it was proposed to Mr. Smith that he should

~~~~~

**'Then, touching a knob, he established communication with the Central Concert Hall, whence our greatest maestros send out to subscribers their delightful successions of accords determined by recondite algebraic formulas.'**

~~~~~  
permit the second part of the experiment to be performed at his residence this evening.

"Agreed. Be here at ten o'clock," answered Mr. Smith; and with that the day's audience was closed.

Left to himself, feeling tired, he lay down on an extension chair. Then, touching a knob, he established communication with the Central Concert Hall, whence our greatest *maestros* send out to subscribers their delightful successions of accords determined by recondite algebraic formulas. Night was approaching. Entranced by the harmony, forgetful of the hour, Smith did not notice that it was growing dark. It was quite dark when he was aroused by the sound of a door opening. "Who is there?" he asked, touching a commutator.

Suddenly, in consequence of the vibrations produced, the air became luminous.

"Ah! you, Doctor?"

"Yes," was the reply. "How are you?"

"I am feeling well."

"Good! Let me see your tongue. All right! Your pulse. Regular! And your appetite?"

"And then?"

"Then, sir, I shall simply have determined the absolute. All I want is money enough to carry my research to a successful issue."

"Very well," said Mr. Smith. "And what will be the practical outcome of your discovery?"

"The practical outcome? Why, that we shall be able to produce easily all bodies whatever—stone, wood, metal, fibers—"

"And flesh and blood?" queried Mr. Smith, interrupting him. "Do you pretend that you expect to manufacture a human being out and out?"

"Why not?"

Mr. Smith advanced \$100,000 to the young chemist, and engaged his services for the Earth Chronicle laboratory.

The second of the four successful applicants, starting from experiments made so long ago as the nineteenth century and again and again repeated, had conceived the idea of removing an entire city all at once from one place to another. His special project had to do with the city of Granton, situated, as everybody knows, some fifteen miles inland. He proposes to transport the city on rails and to change it into a watering-place. The profit, of course, would be enormous. Mr. Smith, captivated by the scheme, bought a half-interest in it.

"As you are aware, sir," began applicant No. 3, "by the aid of our solar and terrestrial accumulators and transformers, we are able to make all the seasons the same. I propose to do something better still. Transform into heat a portion of the surplus energy at our disposal; send this heat to the poles; then the polar regions, relieved of their snow-cap, will become

"Only passably good."

"Yes, the stomach. There's the rub. You are over-worked. If your stomach is out of repair, it must be mended. That requires study. We must think about it."

"In the meantime," said Mr. Smith, "you will dine with me."

As in the morning, the table rose out of the floor. Again, as in the morning, the *potage*, *rôti*, *ragoûts*, and *legumes* were supplied through the food-pipes. Toward the close of the meal, phonotelephotic communication was made with Paris. Smith saw his wife, seated alone at the dinner-table, looking anything but pleased at her loneliness.

"Pardon me, my dear, for having left you alone," he said through the telephone. "I was with Dr. Wilkins."

"Ah, the good doctor!" remarked Mrs. Smith, her countenance lighting up.

"Yes. But, pray, when are you coming home?"

"This evening."

"Very well. Do you come by tube or by air-train?"

"Oh, by tube."

"Yes; and at what hour will you arrive?"

"About eleven, I suppose."

"Eleven by Centropolis time, you mean?"

"Yes."

"Good-by, then, for a little while," said Mr. Smith as he severed communication with Paris.

Dinner over, Dr. Wilkins wished to depart. "I shall expect you at ten," said Mr. Smith. "To-day, it seems, is the day for the return to life of the famous Dr. Faithburn. You did not think of it, I suppose. The awakening is to take place here in my house. You must come and see. I shall depend on your being here."

"I will come back," answered Dr. Wilkins.

Left alone, Mr. Smith busied himself with examining his accounts—a task of vast magnitude, having to do with transactions which involve a daily expenditure of upward of \$800,000. Fortunately, indeed, the stupendous progress of mechanic art in modern times makes it comparatively easy. Thanks to the Piano Electro-Reckoner, the most complex calculations can be made in a few seconds. In two hours Mr. Smith completed his task. Just in time. Scarcely had he turned over the last page when Dr. Wilkins arrived. After him came the body of Dr. Faithburn, escorted by a numerous company of men of science. They commenced work at once. The casket being laid down in the middle of the room, the telephote

**'Left alone, Mr. Smith busied himself with examining his accounts—a task of vast magnitude, having to do with transactions which involve a daily expenditure of upward of \$800,000.**

**Thanks to the Piano Electro-Reckoner, the most complex calculations can be made in a few seconds.'**

was got in readiness. The outer world, already notified, was anxiously expectant, for the whole world could be eye-witnesses of the performance, a reporter meanwhile, like the chorus in the ancient drama, explaining it all *viva voce* through the telephone.

"They are opening the casket," he explained. "Now they are taking Faithburn out of it—a veritable mummy, yellow, hard, and dry. Strike the body and it resounds like a block of wood. They are now applying heat; now electricity. No result. These experiments are suspended for a moment while Dr. Wilkins makes an examination of the body. Dr. Wilkins, rising, declares the man to be dead. 'Dead!' exclaims every one present. 'Yes,' answers Dr. Wilkins, 'dead!' 'And how long has he been dead?' Dr. Wilkins makes another examination. 'A hundred years,' he replies."

The case stood just as the reporter said. Faithburn was dead, quite certainly dead! "Here is a method that needs improvement," remarked Mr. Smith to Dr. Wilkins, as the scientific committee on hibernation bore the casket out. "So much for that experiment. But if poor Faithburn is dead, at least he is sleeping," he continued. "I wish I could get some sleep. I am tired out, Doctor, quite tired out! Do you not think that a bath would refresh me?"

"Certainly. But you must wrap yourself up well before you go out into the hall-way. You must not expose yourself to cold."

"Hall-way? Why, Doctor, as you well know, everything is done by machinery here. It is not for me to go to the bath; the bath will come to me. Just look!" And he pressed a button. After a few seconds a faint rumbling was heard, which grew louder and louder. Suddenly the door opened, and the tub appeared.

Such, for this year of grace 2889, is the history of one day in the life of the editor of the Earth Chronicle. And the history of that one day is the history of 365 days every year, except leap-years, and then of 366 days—for as yet no means has been found of increasing the length of the terrestrial year. □





# RUNEQUEST

BY STEVE PERRIN  
AND FRIENDS

Runequest is a role-playing fantasy adventure game (see *Dragonsmoke*, People's Computers, Volume 7, No. 2, Sept-Oct 1978). In this and future issues of RC we will continue to publish excerpts from Runequest and begin building computer programs to (1) assist a gamemaster conduct a game of Runequest or (2) implement a simple form of Runequest as a computer game. If you wish to play along, we suggest you get your very own copy of Runequest for \$8 from The Chaosium, P.O. Box 6302, Dept. P, Albany, CA 94706.

Here are more excerpts from Runequest.

©1978 Chaosium

## HOW TO CREATE AN ADVENTURER

To create a human Adventurer, the player rolls 3D6 for each of the following characteristics. This provides a range of from 3 (low) to 18 (high) for each characteristic and this range gives the basic parameters of Human development. Other races such as Elves, Dwarves, and Dragonewts may have different ranges for many characteristics. These differences are dealt with in the section on Monsters, Chapter VIII.

**1. STRENGTH (STR)**—An Adventurer's strength affects the damage he does, the kind of armor he wears, and what weapons he can wield. It can be increased through training, explained later, up to the rating for the character's Constitution or Size, whichever is largest. If STR is a character's highest rating of the three, then it cannot be increased except by magic.

**2. INTELLIGENCE (INT)**—This characteristic is trickier. It is a measure of an Adventurer's ability to deal with abstractions and memorization. This includes the theory behind skills such as fighting, thieving, magic, and crafting. INT is the major modifier of a character's ability to progress in skills through experience. It also determines how many spells a character may memorize. This characteristic never changes, save through some miraculous intervention.

**3. POWER (POW)**—This represents a character's ability to work magic. It is also the measure of his soul. A high POW shows the favor of the gods, allowing an Adventurer to hit easier, defend himself, and otherwise excel, for he is in tune with the Universe. Of course, a high POW detracts from an Adventurer's ability to skulk around in shadows and remain unobtrusive, for the aura of POW draws attention. POW varies over time. Spell use depletes a character's POW, and rest restores it. Successful spell casting can cause an Adventurer to gain more POW. Full rules for this are given in Chapter V, Basic Magic.

**4. CONSTITUTION (CON)**—This is the measure of the health of a character. It is the major factor in determining the amount of damage a character can take before he dies. The CON of an Adventurer is what all attacks by Poison or Disease must be matched against. Training can increase CON. It can be increased up to the rating for the character's STR or Size, whichever is largest. If CON is the character's highest rating of the three then it cannot be increased except by magic.

**5. DEXTERITY (DEX)**—This is the measure of how fast and accurately a character can perform different functions such as fighting and magic. DEX can also be raised by training up to the limit of the species maximum, explained later in this chapter.

**6. CHARISMA (CHA)**—CHA is the measure of leadership. This is the ability to say "follow me" and find oneself leading a charge. It should not be mistaken for beauty. CHA is useful for obtaining training cheaply and has various other uses which will become apparent throughout the rules. CHA can be changed by the success or failure of previous ventures which have a definite influence on the Adventurer's current CHA.

**7. SIZE (SIZ)**—This indicates the mass of a character. It affects his ability to do and absorb damage. Both large and small SIZ Adventurers have certain advantages. Large persons can absorb and deal more damage, but find it hard to defend themselves and hard to skulk in shadows. Small people have the opposite benefits and drawbacks. SIZ cannot be naturally altered.

*This is only the beginning of how to create an adventurer. More next time. In the meantime, here is a TRS-80 program to roll the seven basic characteristics. It simulates rolling three six-sided dice (3D6) for each characteristic, then puts the results on the screen.* □

```
100 REM***CREATE A RENEQUEST ADVENTURER
110 RANDOM
120 GOSUB 910 : STR = ROLL
130 GOSUB 910 : INX = ROLL      INT is a reserved word, so
                               we use INX.
140 GOSUB 910 : POW = ROLL
150 GOSUB 910 : CTN = ROLL     CON contains ON, which
                               is a reserved word, so we
160 GOSUB 910 : DEX = ROLL     use CTN.
170 GOSUB 910 : CHA = ROLL
180 GOSUB 910 : SIZ = ROLL
190 CLS
200 INPUT "WHAT IS THE NAME OF YOUR ADVENTURER";NAME$
210 PRINT
220 PRINT NAME$;" HAS THESE CHARACTERISTICS:"
230 PRINT
240 PRINT "STRENGTH:      STR =";STR
250 PRINT "INTELLIGENCE:  INT =";INX
260 PRINT "POWER:         POW =";POW
270 PRINT "CONSTITUTION:  CON =";CTN
280 PRINT "DEXTERITY:     DEX =";DEX
290 PRINT "CHARISMA:     CHA =";CHA
300 PRINT "SIZE:         SIZ =";SIZ
310 STOP
900 REM***SUBROUTINE: ROLL 3D6 DICE
910 ROLL = RND(6) + RND(6) + RND(6)
920 RETURN
999 END
```

# A Different **FORTRAN** **MAN** SCENARIO

BY SAM HILLS

*I have enjoyed your series, FORTRAN MAN. But, one thing puzzles me: How come the hero of the story is an archaic, awkward language like FORTRAN????? I could understand his defeating an ungainly monster like COBOL, but it seems strange that FORTRAN would be considered the hero over ALGOL! (Well, maybe the old ALGOL 60 compiler; I've heard it wasn't so hot.) But now that we have modern, well-structured general purpose languages like PASCAL and special-purpose languages like PILOT and SNOBOL, FORTRAN is no longer a hero! (And BASIC??? He's one of the worst villains of them all!)*

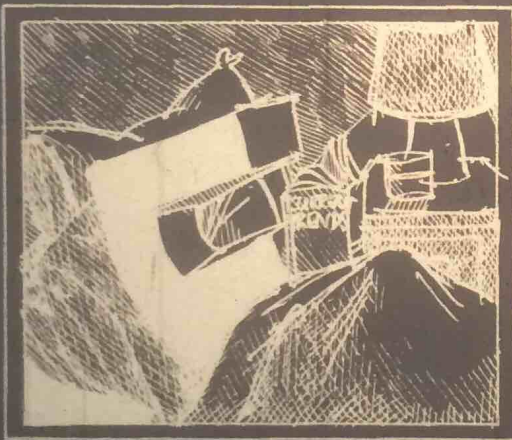

*In keeping with the current trend in programming languages and maybe to give a hint to users of the old, poorly structured monsters like FORTRAN and BASIC, I propose the following scenario:*

FORTRAN Man has just arrived in 360 City, and is ready to get down to work. He checks with the job controller to see if there are any evil programs terrorizing the system, and sure enough, there are. He reads the charges, and they are very serious: lack of adequate control structures; insufficient variable types; no local subroutines; a very awkward system of global variables; no nested control structures; excessive use of GOTOs, ad infinitum. And there are rumors that this diabolical program has an accomplice who is even worse than *he* is!



Naturally, our hero wastes no time in seeking out this dastardly villain. But imagine his surprise when he finds out that the villain is none other than himself! And his accomplice is none other than his own son, Billy BASIC!

Well! FORTRAN man is really mad. He asks who has the audacity to FILE these charges against him? He soon finds out that the foe he recently defeated, Count ALGOL, also had a son: PASCAL! And, unlike the Count, PASCAL wasn't a deadly file-killer.



Eventually, FORTRAN Man and PASCAL are face-to-face in a battle of the compilers. All the files in 360 city are there to watch the showdown. Most of the files have wagered their bits on FORTRAN man, since PASCAL isn't a native of 360 City; besides he isn't even a son of the great father IBM!

The battle begins! PASCAL challenges that FORTRAN Man has a poor selection of variable types. Fortran Man counters by showing his COMPLEX and DOUBLE PRECISION, to which PASCAL responds RECORD, SET, FILE and SCALAR.



The contest CONTINUES with a compilation race. The monitor clears the race track for ten different programs, ranging from simple games to gigantic statistical packages. The race begins! And the winner is . . . PASCAL! Having compiled his programs in a single pass, he sits back and laughs while FORTRAN Man labors with his second, third, fourth, etc. passes, trying to resolve his COMMON and EQUIVALENCE statements and statements which use keywords for variables (like CALL=3.4 and DO10I=1.5).



Trying to help, Billy BASIC points out some of the features that his dad has, but which he lacks. "Show him your FORMATS, Dad. And don't forget your subroutines with parameters!"

PASCAL responds by showing his READ and WRITE procedures with built-in formatting: "What do I need with your awkward FORMAT statements? I have it all right here."

"And the parameters of my subroutines can specify whether they pass data one way, or both ways!"

The battle rages fiercely. FORTRAN Man is considerably weakened by PASCAL's attacks of GOTO abuse, and contorted logic flow necessitated by a lack of an adequate IF.

At last, PASCAL pulls his final punch: He calls himself recursively! FORTRAN Man, weakened to the point of exhaustion by the multiple copies of PASCAL, doesn't realize what PASCAL has done, and tries the same thing himself, but since FORTRAN Man isn't stack-oriented, he clobbers his own return address in the process. PASCAL sees what has happened, and shouts a single statement: "RETURN!" FORTRAN Man, having clobbered his return address with a recursive call, is hopelessly caught in an endless loop from which he can never escape!



And so, PASCAL goes forth into the CORE of 360 City, the True defender of rational programming and the Algorithmic way.

(As for Billy BASIC, he was so tired from having to retype an entire line just to change one letter, that when someone RENUMBERed his source file, he forgot to change one of his GOSUBs, and he was last seen branching towards a non-existent line number . . . )



Note: The regular FORTRAN MAN will return next issue.

# APPLE II: EASY I/O SENSING & CONTROL

BY CHUCK CARPENTER

Chuck is an avowed member of the Apple Corps from Carrollton, Texas. He says he wants to see more published information on the Apple II and to support that interest he created the original article that follows. That is the way it works . . . we have never published an article we have never received. But we do publish most of what is sent to us. So let's see more Apple users sending stuff this way.

Attached to Chuck's article was a list of items. It was not clear whether he was making up a menu or perhaps suggesting titles for new articles. The list ran on with things such as: Apple Sauce, Apple Pie, Apple Fritters, Apple Tarts, etc . . . Or perhaps these are the names of some of the PILOT programs Chuck plans to contribute in the future . . . -RZ

One significant but unheralded feature of the Apple II is the 16 pin game I/O connector. With a minimum of connections, many "outside world" occurrences can be sensed and controlled. Here's what's available:

- Four latching TTL level bits to turn things on and off.
- Three TTL level sense bits to check for switch closure (and opening)

- Four TTL analog inputs for sensing control positions or measuring temperature or whatever.
- One TTL utility strobe so you can control things in time with the computer.

All of these are under control of features built into the Apple II firmware and monitor programs in ROM.

## APPLE II TURN-ON

Using a POKE command you can set one of the latching bits to turn on an indicator, such as a lamp or LED. With another, you turn it off. Using all 4 latching bits and a 1 of 16 decoder chip (e.g. a 74154 chip), 16 items can be under software control. (See Figure 1.) The 5 volt power supply needed for the chip is also available from the game I/O connector. Caution here: don't use more than 100 milliamps from the 5 volt pin. You should use a separate power source for loads that need more than 100 milliamps of current. The 4 latching bits are called annunciator outputs, AN0 thru AN3. When needed, be sure to use appropriate buffers to invert the logic sense and isolate the loads. Figure 2 shows some possibilities.

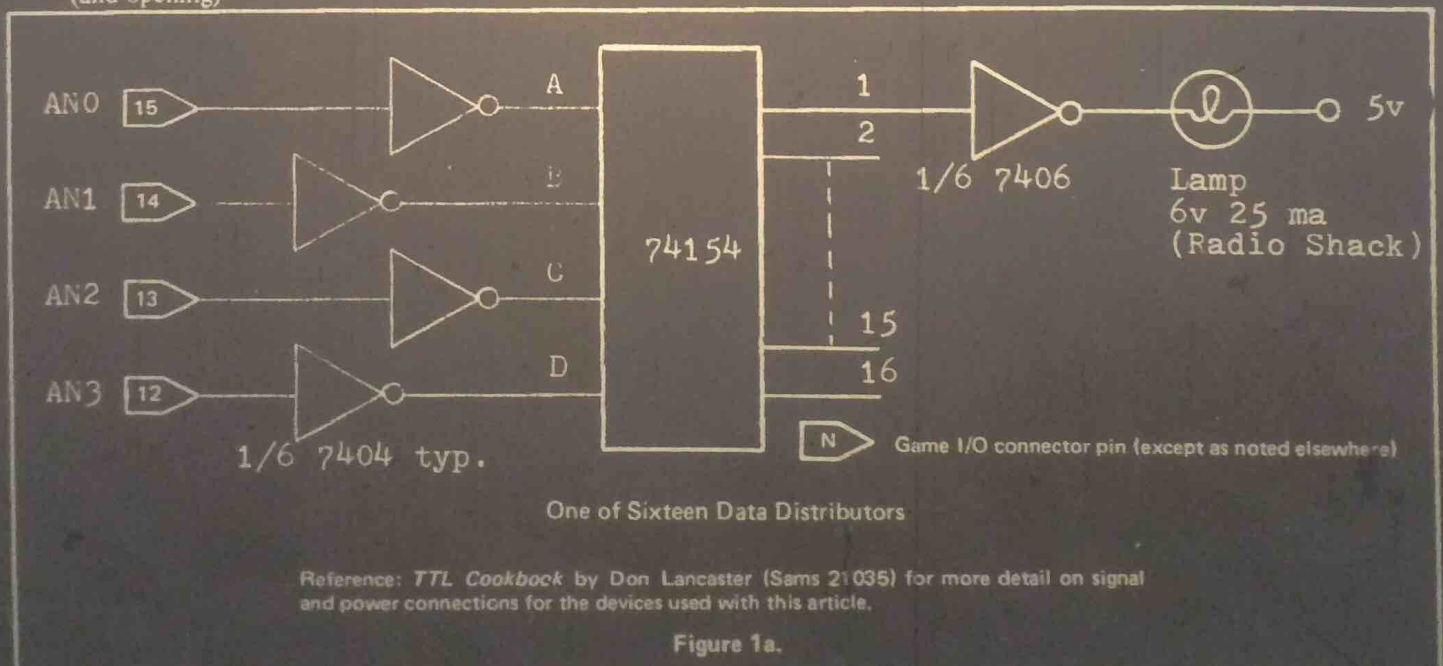

OUTPUT		1	2	3	4	5	6	7	8	9	10	11	12	13	14	15	16
I N P U T	ANO (A)	0	1	0	1	0	1	0	1	0	1	0	1	0	1	0	1
	AN1 (B)	0	0	1	1	0	0	1	1	0	0	1	1	0	0	1	1
	AN2 (C)	0	0	0	0	1	1	1	1	0	0	0	0	1	1	1	1
	AN3 (D)	0	0	0	0	0	0	0	0	1	1	1	1	1	1	1	1

Truth Table for AN(X) Input to 74154 Output

ANO thru AN3 normally HI (1)  
 POKE -16295,0 sets AN0 LO (0) (C059)  
 POKE -16296,0 clears it HI again (C058)

AN1 = -16293 and -16294 (C05A and C05B)  
 AN2 = -16291 and -16292 (C05C and C05D)  
 AN3 = -16289 and -16290 (C05E and C05F)

Figure 1b.

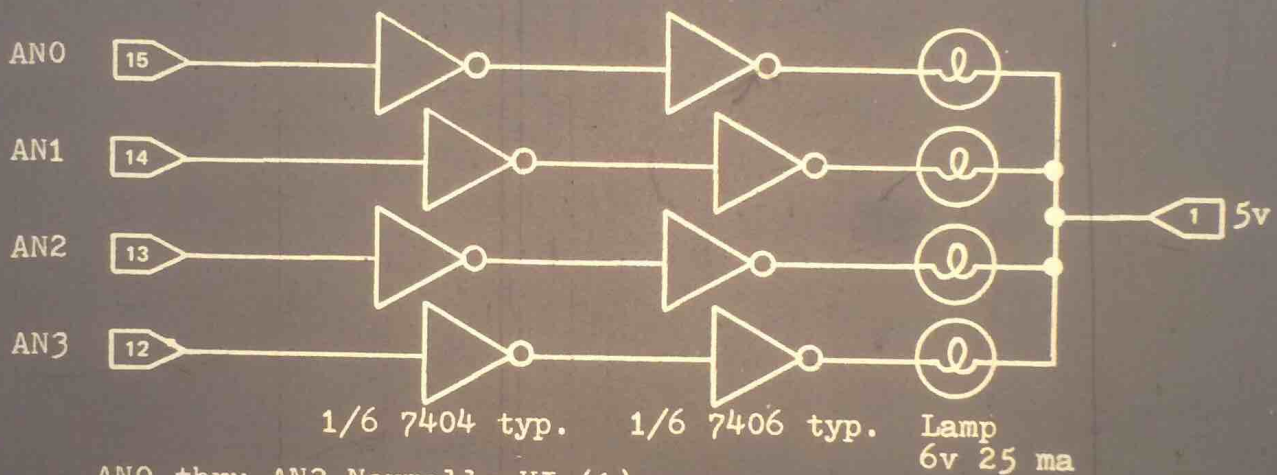

ANO thru AN3 Normally HI (1)

Typical Apple II Lamp Driver Circuit

If LED indicators were used in place of incandescent lamps, 7404's could be used for both TTL devices.

Example:

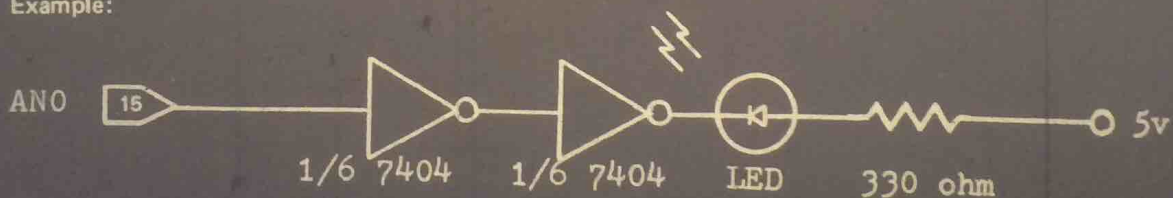

LED Lamp Driver

With suitable external power supply capacity, lamps can be replaced with relays and many other control devices.

Figure 2

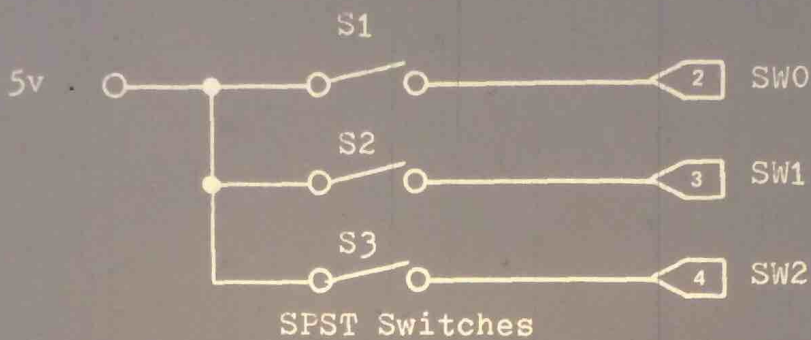

Example of elementary switch sensing circuit

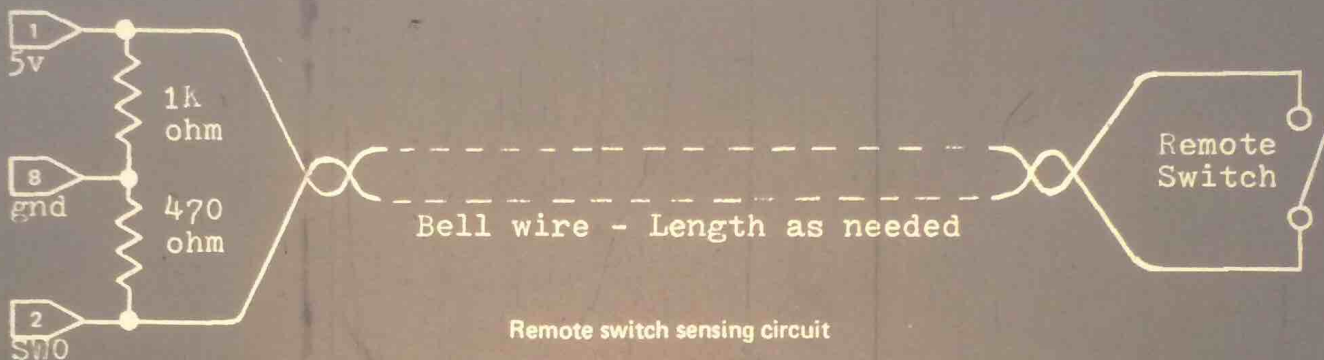

Parts can be assembled on a 16 pin header and plugged into the game I/O socket.

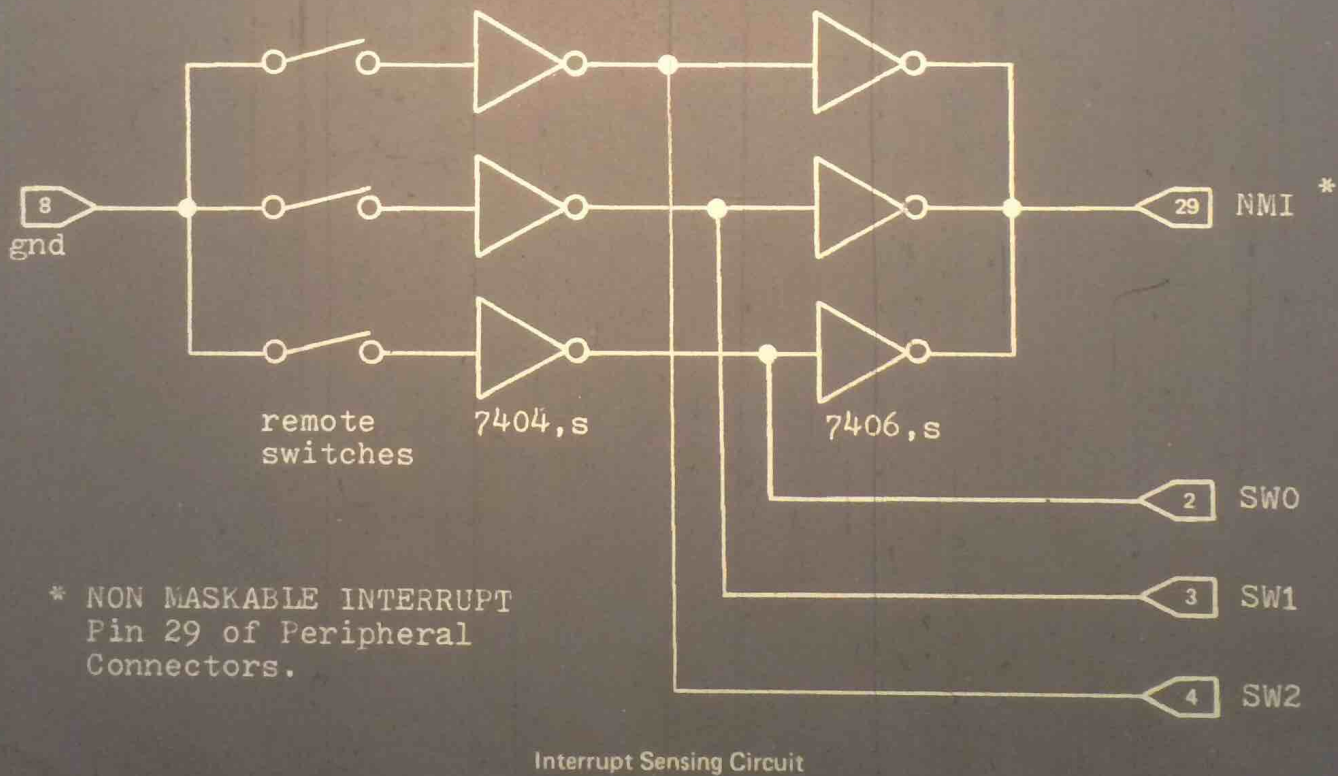

\* NON MASKABLE INTERRUPT  
Pin 29 of Peripheral  
Connectors.

Figure 3a.

```

>LIST
5000 REM ** SWITCH TEST ROUTINE **
5001 REM *****
5002 REM
5100 IF PEEK (-16287)>127=1 THEN
PRINT "SWITCH ONE IS ON"
5200 IF PEEK (-16286)>127=1 THEN
PRINT "SWITCH TWO IS ON"
5300 IF PEEK (-16285)>127=1 THEN
PRINT "SWITCH THREE IS ON"
5400 REM
5401 REM * 'SWITCH ON' CAN ALSO BE
5402 REM * 'INTERRUPT ON' AND PRINT
5403 REM * A CORRESPONDING MESSAGE.
5404 REM
5500 RETURN

```

Note: Peek( (location) )>127=1 is testing a memory location representing the switch input. When the switch is open the value will be less than 127. Closed, the value will be greater than 127. The expression is then true and prints the message. (-16287=C06116 etc.)

Figure 3b.

### WHAT'S HAPPENING?

Three addressable inputs (using a PEEK command) allow you to test the state of switches or contacts. These inputs are often used in conjunction with the game paddle switches to control events and change game conditions. Other possibilities might include monitoring remote sensor switches for gate or door control or filling your swimming pool. Used in conjunction with the interrupt circuits in the Apple II, these switch inputs can indicate the source of interrupt (up to three anyway). Figure 3 shows one way this can be done. A short program to monitor the pins, SW0 thru SW2, is also included.

### WHICH WAY DID HE GO?

Analog inputs can be sensed through 4 other pins called PDL0 thru PDL3. With the game paddles connected, these inputs sense the position of the game paddle and provide a corresponding program readable output. For instance, with the game paddle at one end of its range, the analog output indication has a value near or at zero. At this point, an input of 3 or more volts is required. At the other extreme, the analog output value is 255 and an input voltage near zero is needed. The change of voltage is provided by a variable resistor. The output varies in proportion to the position of the game paddle control arm.

This analog feature can also be used to sense a temperature change. With the thermistor circuit shown in Figure 4, relative temperature can be measured. By calibrating the circuit at a known temperature, changes in temperature can be detected. (With somewhat more sophisticated circuits, absolute temperature can be measured. This requires using the temperature probe in a linear region and amplifying the change in resistance as a function of temperature.) Such capability could find application in physics and chemistry experiments and other scientific fields.

Additionally, the analog inputs can be used where any changing voltage is present and fast response time is not a prime factor. Wind direction and speed, rotational position of motors and other mechanical motion/position sensors are typical examples.

### THERE'S MORE

And remember, all this is possible with little or no additional interface circuitry. With other systems, such capability requires expensive circuit boards and/or time to collect and assemble the parts. Having program controllable I/O capability already wired-in considerably enhances the usability of a personal computer.

Apple has thoughtfully provided several I/O functions as an integral part of the Apple II computer. As an added bonus, a printer or teletype can be controlled from the game I/O connector. I drive my Telpar thermal printer this way. A friend drives his Practical Automation printer from one of the annunciator outputs. All without additional interface boards. And Apple provides a driver routine (in the reference manual) for communicating with a teletype machine. This routine uses a simple adapter circuit (also provided in the manual). Another local Apple Corps member is using this with his teletype. Perhaps you can find a unique application for the versatile I/O capability provided by the Apple II game connector. □

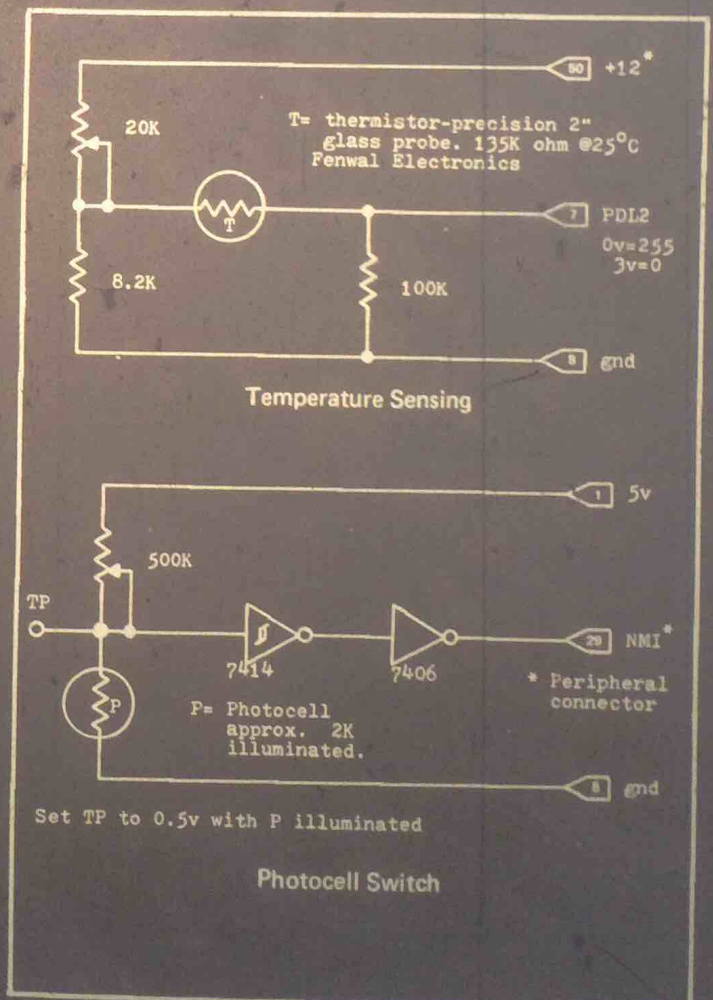





```

710 GOTO 640
720 LET N1=A
730 IF N1=0 GOTO 960
740 Q1=L2 \ Q2=2*N0 \ Q3=INT(N1/3) \ IF Q1<Q2 GOTO 760
750 Q1=Q2
760 IF Q1<Q3 GOTO 770 \ Q1=Q3
770 IF Q1=0 THEN 940
780 PRINT"CUANTAS HECTAREAS PARA SEMBRAR (MAX. ";Q1;")";
790 INPUT L3
800 LET L3=INT(L3)
810 IF L3<0 GOTO 1930
820 IF L3=0 GOTO 970
830 IF (I,2-L3) >=0 GOTO 860
840 PRINT"SOLAMENTE TIENE"L2"HECTAREAS!"
850 GOTO 780
860 IF (2*N0-L3) >=0 GOTO 890
870 PRINT"SU POBLACION ES SOLAMENTE"N0"PERSONAS"
880 GOTO 780
890 LET A=N1-3*L3
900 IF A>=0 GOTO 930
910 PRINT"SOLAMENTE TIENE"N1"ARROBAS EN ALMACENAJE!"
920 GOTO 780
930 LET N1=A
940 IF N1>0 GOTO 970
950 PRINT
960 PRINT"SU ALMACENAJE ESTA VACIO...BUENA SUERTE!"
970 LET Y=Y+1
980 LET N3=FNR(N0/3+3)
990 LET N4=FNR(N0/4+2)
1000 LET N5=N0-INT(N2/10)
1010 IF N5>0 GOTO 1090
1020 IF N5=0 GOTO 1140
1030 LET A=FNR(3-N5/2)
1040 PRINT
1050 PRINT"***EXCESO DE COMIDA*** POBLACION AUMENTA";A
1060 LET N5=0
1070 LET N3=N3+A
1080 GOTO 1140
1090 IF (FNL(5*(N5-2))) >0 GOTO 1140
1100 LET A=FNR((N5*N1)/(2*N0))
1110 PRINT
1120 PRINT"***REVUELTA DE HAMBRE*** "A"ARROBAS PERDIDOS"
1130 LET N1=N1-A
1140 IF FNL(10) >0 GOTO 1190
1150 LET A=INT(N0/3)+FNR(N0/2+2)
1160 PRINT
1170 PRINT"***PLAGA*** "A"PERSONAS MURIERON"
1180 LET N4=N4+A
1190 IF FNL(10) >0 GOTO 1290
1200 LET A=FNR(N0/5)+INT(N0/5)
1210 LET B=FNR(N1/20)+INT(N1/20)
1220 LET C=FNR(L2/50)
1230 PRINT
1240 PRINT"***LOS REVOLUCIONARIOS ATACAN***"
1250 PRINT"A"PERSONAS MURIERON;"B"ARROBAS ROBADAS;
"C"HECTAREAS DESTRUIDAS"
1260 LET N4=N4+A
1270 LET N1=N1-B
1280 LET L2=L2-C
1290 IF FNL(15) >0 GOTO 1360
1300 LET A=FNR(20)+10
1310 LET B=FNR(N0+250)+50
1320 PRINT
1330 PRINT"***EXPANSION DE FRONTERA***"
1340 LET N3=N3+A
1350 PRINT"USTED GANO;"A"PERSONAS;"B"HECTAREAS"
1360 LET N0=N0+N3-N4-N5
1370 IF N0<=0 GOTO 1860
1380 PRINT
1390 PRINT N3"PERSONAS LLEGARON"
1400 PRINT N5"PERSONAS MURIERON DE HAMBRE"
1410 PRINT N4"PERSONAS MURIERON DE CAUSAS NATURALES"
1420 IF FNL(10) >0 GOTO 1470
1430 LET A=FNR(N1/20)+INT(N1/20)
1440 PRINT
1450 PRINT"***ROBO*** "A"ARROBAS ROBADAS"
1460 LET N1=N1-A
1470 IF FNL(10) >0 GOTO 1520
1480 LET A=FNR(L2/10)+INT(L2/20)
1490 PRINT
1500 PRINT"***TERREMOTO*** "A"HECTAREAS DESTRUIDAS"
1510 LET L2=L2-A
1520 IF FNL(15) >0 GOTO 1570
1530 LET A=FNR(100+INT(L2/100))+500
1540 PRINT
1550 PRINT"***LLEGO EMBARQUE DE GRANO*** "A"ARROBAS"
1560 LET N1=N1+A
1570 IF FNL(15) >0 GOTO 1620
1580 LET L1=FNR(2)+1
1590 PRINT
1600 PRINT"***SEQUIA***"
1610 GOTO 1710
1620 IF FNL(15) >0 GOTO 1670
1630 LET L1=FNR(3)+7
1640 PRINT
1650 PRINT"***TORMENTA***"
1660 GOTO 1710
1670 LET L1=FNR(4)+3
1680 REM
1690 REM **CALCULO DE LA COSECHA***
1700 REM
1710 LET A=L1*L3
1720 LET B=FNR(A/4)
1730 LET C=A-B
1740 PRINT
1750 PRINT
1760 IF A=0 GOTO 1810
1770 PRINT"LA COSECHA FUE"LI"ARROBAS POR HECTAREA;
UN TOTAL DE"A"ARROBAS"
1780 PRINT"PERDIDA POR RATAS FUE"B"ARROBAS;
LA COSECHA NETA FUE"C" ARROBAS"
1790 LET N1=N1+C
1800 GOTO 200
1810 PRINT"LA COSECHA FUE"LI"ARROBAS POR HECTAREA,
UN TOTAL DE"A"ARROBAS"
1820 GOTO 1790
1830 PRINT
1840 PRINT"***FELICITACIONES*** ¡¡UD ES EL JEFE DEL MUNDO!!"
1850 GOTO 1950
1860 PRINT
1870 PRINT"***DESASTRE*** TODOS MURIERON"CHR$(7);CHR$(7);CHR$(7)
1880 GOTO 1950
1890 LET Q=INT(RND(0)*5)+1
1900 IF Q=3 THEN 1920
1910 GOTO 340
1920 PRINT"***REVUELTA***"
1930 PRINT"USTED HA SIDO DESTRONADO!!"
1940 PRINT"LA CHUZMA HA TOMADO EL CASTILLO,
Y USTED HA SIDO PUESTO EN LA CARCEL"
1950 PRINT
1960 PRINT"SU REINO FUE"
1970 STOP
2046 END

```



# DRAGON SMOKE

BY THE DRAGON

Last time, we mentioned *Chivalry & Sorcery*, a mind-boggling encyclopedia/rulebook for creating fantasy adventure. Here is a review, courtesy of Greg Stafford of The Chaosium, P.O. Box 6302, Albany, CA 94706.

## CHIVALRY & SORCERY

Dear Bob (& crew),

It is a pleasure for me to introduce the excellent line of *Chivalry & Sorcery* books to your readers. They are such superb reference resources that their interest range extends far beyond the immediate field of gaming. And, for a crew with analytical minds plus access to a data retrieval system like computers, these books are a goddess-send.

*Chivalry & Sorcery* was the first of the series to be released. It came out in mid-summer '77 and immediately took the fantasy role-playing world by storm. The worst complaints which I have read about it are that the print is too small, and the system is too real! Concerning the first complaint, publisher Scott Bizar states simply that if he had used regular-sized type, the book would have cost \$15, rather than \$10. The "realism" complaint is the result of the (sometimes massive) amount of record-keeping necessary for a full campaign game. (*Aha! A "fantastic" computer application* -Ed.)

*Chivalry & Sorcery* sets up a structure for an entire fantasy world, based on the European Middle Ages. It has rules for all the necessities of fantasy role-playing games: combat, magic (including every type of magic in the Middle Ages, from alchemists and Christian mystics to shamans and magical elves), ways to

better yourself in the world, and so on. The economics of the system allow for a wide range of variables in determining land values, the cost of hiring servants, buying a meal, or raising a monumental citadel.

The *Chivalry & Sorcery Sourcebook* is the second in the series. This includes notes (and charts) on designing outdoor encounters, stats for pre-figured holdings, and considerable discussion of world-building philosophy and methods. In this latter category are essays on how to construct an ecologically viable magical creature. This is, in turn, based on an essay about the Laws of Magic, in which *Authentic Thaumaturgy*\* is cited as a major source.

*Swords & Sorcerers* explores and sets statistics for the barbarians popular to much of fantasy: the Celts, Nordics, and Steppe Nomads (specifically the Mongols). Again, there are economic stats, and copiously detailed notes on the special magics of those peoples.

*Bireme & Galley* is a naval war game put out by the *Chivalry & Sorcery* crew. I think the book is available alone, but it normally comes with small ship outlines, to be photocopied for fleet actions, and large folded 25mm scale deck plans for FRP games with figures. There are other playing aids, too, but the most important part is the book. It contains detailed descriptions and drawings of the

AND FRIENDS

warships and merchant ships of ancient and medieval times. This includes tonnage, dimensions, crew, turning radius, average speeds (under different wind and sea conditions), cargo capacity, and so on.

I myself have used sections from all of these books in my own *Dragon Pass* campaign. They are invaluable as idea sources, for those sections which you do not lift out wholesale for your personal use. I do not use the combat or magic system in my *Runequest* world, of course, but the other material is more valuable than weeks in study.

I cannot recommend these books highly enough. I am sure that they will become an authority because of their thoroughness. They are the result of many years of study and work by a band of dedicated fanatics and lovers of the art. They are monumental.

I am sure that anyone who purchases these will be satisfied. The publisher is so confident that he states he will refund the money of any dissatisfied customer. Scott tells me none of the thousands of purchasers has ever complained.

Sincerely,



Greg Stafford  
"Magister" Chaosium

From: Fantasy Games Unlimited, P.O. Box 182, Roslyn, NY 11576. Price: \$10.

\* *Authentic Thaumaturgy* was reviewed in the Nov-Dec 1978 issue of *People's Computers*. See "Dragonsmoke" in that issue.

## CHINESE DRAGONS POSTER



### General Nature of Dragons—

A sixth century work says "A *Water Snake*, after 500 years, changes into a *Pond Dragon*, which after 1000 years changes into a *Dragon*, which after 500 years becomes a *Horned Dragon*, and then after 1000 years becomes a *Winged Dragon*." Many forms of each are pictured and described in Chinese Art and Literature. They are rough and fierce yet benevolent, large enough to fill all space or small as a silkworm at will, and assume many shapes for special tasks.

In general, dragons are worshipped as producers of fertilizing rain. In recent times, dragons with 5 claws were deemed Imperial.

1. *Lung*, The Chief Dragon. Has the head of a camel, rabbit eyes, deer horns, cow ears, snake neck, frog belly, carp scales, bird claws, and palms of a tiger. Has whiskers and a beard containing a pearl. Its breath changes into water or fire, and its voice is like the jangling of copper pans. Its ears are deaf, but it hears through its horns. There are 81 scales (points?) down the back. Rain dragon.

*Lung* came from the poster of *Chinese Dragons* published by W. M. Hawley, 8200 Gould Avenue, Hollywood, CA 90046. This poster has 41 dragons. You can get it in two sizes: 17 x 22 for \$0.50; 22 x 30 for \$1.00. Add 20% for postage and handling and, if you live in California, 6% tax.

## FLYING BUFFALO, INC.

Every few years, we like to remind you about Flying Buffalo, Inc. Among other things, Flying Buffalo, Inc. runs play-by-mail games such as STARWEB, a strategic space game, TUNNELS AND TROLLS, a fantasy adventure game and several others. Some of these are computer-based games; others are run by human game masters. Keep up with Flying Buffalo by subscribing to *Flying Buffalo Quarterly*. Four issues per year for \$4.

For you fantasy adventure game fans, Flying Buffalo, Inc. is starting a new quarterly. Here is what they say about it:

### SORCERER'S APPRENTICE

*A new Magazine for Fantasy Role-playing Game Fans.*

*A quarterly magazine produced by Flying Buffalo Inc., full of fantasy role-playing games material. Thirty-two full-size (8½ x 11) pages, slick and good-looking! We are including solo dungeon adventures, complete dungeons for dungeon-masters, descriptions of the best dungeon trips by our play-by-mail dungeoners, articles, and fiction by well-known authors and a few who deserve to be better known.*



*Edited by the irrepressible Ken St. Andre. Art by the incredible Liz Danforth. Tunnels and Trolls dungeon trips by the innumerable Phoenixfen. And fiction!*

*A subscription to Sorcerer's Apprentice will cost you \$8.00 for 6 issues, a year and a half! Flying Buffalo Inc., P.O. Box 1467, Scottsdale, AZ 85252* □

# Reviews

## 3-DIMENSIONAL MONSTER MAZES

By Larry Evans

Troubador Press, 1976

40 pp. \$1.95

If monsters and mazes turn you on, so will this book. The mazes are maddening enough to grab even the hardened puzzle freak, and the graphics are so vivid and crazy, they could grab just about anybody. The maze reproduced below, "St. George and the Dragon," is one of the tamer entries, visually speaking, but, well, you understand how PCC feels about dragons.

The book's 20 mazes run the monster gamut—from a burned-out brain to a plunging snake pit—and each is accompanied by a helpful hint, such as: "Earl, the ant, wants to visit with his Aunt Agatha. Earl is on the lower branch and he must crawl past the sleeping spider to the upper limb. He may crawl over and under the strands of the web, but he'd better be quiet; spiders are light sleepers."

Three-D mazes are a different kind of challenge. As author-illustrator Larry Evans puts it in his introduction, "A 3-dimensional maze confronts you with a variety of problems not found in a regular line maze: paths cross over and under each other; roads cross over and under bridges; you are asked to stay *inside* hoses and tubes."

This collection is just one of eight maze books published by Troubador Press, which also specializes in coloring books and model-building books. Troubador books are available nationwide at book, gift, toy, educational, art, math, and museum stores. To find a store near you, contact the publisher at 385 Fremont St., San Francisco 94105.

Reviewed by Louise Burton

*"St. George and the Dragon" Maze.*  
Reproduced by permission of the publisher from *3-Dimensional Monster Mazes* by Larry Evans ©1976, Troubador Press, 385 Fremont St., San Francisco 94105.

## SENSIBLE MARKING FOR A BASIC EDUCATION

Mark Sense BASIC Cards

Compute-A-Bit Corporation

LaGrange Park, IL

The microcomputer has been hailed as the way to provide the interactive computing needed to make computers more real to the students. Since the microcomputer broke the back of the computer price curve, systems have become affordable to numerous high schools and other institutions that could never have them before. On-line systems can be used much to the delight of instructors and students . . . up to a point. The point of conflict comes when the realities of too many students and too much demand for on-line time bump into the limitations of too few microcomputers. We faced this crunch before with the bigger systems. We solved the problems through time sharing and by using punch cards. Should we use the same approach again?



Not too long ago that would have been an empty question. Time sharing for micros has been slow in coming and punched cards...ugh! But now a Chicago area company has both time sharing software for microcomputers and a complete system for using mark sense cards on a micro in BASIC programming language.

The Compute-A-Bit Corporation in La-Grange Park, Illinois, is a well established firm with a history in micros that goes back to the first IMSAIs. They have had a close relationship with many of the educational institutions in the area and they have aimed their time sharing and mark sense systems at educational users.

Both the multiple user system and the Mark Sense Batch BASIC are extensions of IMSAI BASIC 9B. The customer must either have or purchase BASIC 9B.

The multiple user system will allow a microcomputer to accept up to six RS-232 terminals. Each terminal is, of course, time sliced into the master program, but each user appears to have a dedicated computer system. An instructor or computer operator can determine the amount of memory available to each user. The software costs about \$800 (plus the IMSAI 9B), but this system does provide one approach to giving many students a feel of "on line" computing.

Still, active students may have legitimate scheduling difficulties which prevent them from getting to a terminal. Some means of allowing them to write programs at home that will load and run in class would be very useful. Mark Sense BASIC provides this capability. Instead of using 80 column punch cards, the students mark with an ordinary pencil on specially designed 40 column cards that even include BASIC statements and commands. Each 40 column card can be extended to the next card to give an 80 column capability.

**Playing With A Full Deck.** At first I was skeptical about the use of these cards. They seemed to be too much of a throw-back to the "bad old days." I became a believer, however, when on a short plane ride from Chicago to St. Louis, I learned to encode the cards and wrote a 60 line original BASIC program between take-off and landing. By touch-

down, I was writing BASIC lines faster than many hunt-and-peck typists. Students can use this system in their homes or at odd hours when terminals or keypunch machines normally would not be available. Marks are easily changed and program errors can be corrected about as fast as they could be with a keyboard and video terminal.

The cards themselves are EBCDIC coded. The coding sequence can either be learned logically or copied from a table. The manual for the system is a very complete 55-page print-out of descriptions, instructions, and sample programs.

**Ouch!** There seems to be only one thorn among all of these roses. These cards have to be read and to do that an electro-mechanical device is needed. The reader, a TM-200, sells for about \$3900. Add this to the software and you are nudging \$5K for a card input capability. This looks ridiculous next to the cost of the CPU, but if you consider the way in which it multiplies the number of users you can get on a CPU, the thorn loses some of its sting. It is also a small sum when compared to what businesses and institutions have been paying for card punches. Oh, speaking of punched cards; if they have got to be a part of your lesson plan, this system can use them totally or intermixed in a deck with mark sense cards.

**Run.** In actual use, many students would combine their decks into one big stack with EOF (End Of File) cards between each program. Many parameters can be limited by pre-set supervisory instructions. The number of cards, number of lines, and actual number of minutes devoted to each program can be limited. Students usually receive the output from the computer in hard copy, so the type of printer available usually determines how many programs can be run during a class period. Each program is run individually and fast feedback is available to the students.

**Potshoi.** I've been through the Mark Sense Batch BASIC several times and I'm quite impressed. The only nit I can find to pick comes from their labeling of BASIC commands and statements. I was always taught that INPUT, GOTO, IF, etc. were BASIC "statements" and that LIST, SAVE, RUN, etc. were BASIC "commands." Although they are referred

to correctly in the manual, they seem to be labeled backwards on the cards. This is a very small point to normal users, but in an entry level educational course, the students could pin you to the wall on that one.

Another more serious sticking point can come in the integration of the hardware needed to run this super software. Getting the clock driven interrupts in at the right time is critical in these systems. This is not a job for the "marginal digital hacker" and expert help may be needed.

In summary, the Compute-A-Bit corporation has come up with a good blend of old ideas and new technology for classroom use. Educators and others with unique requirements that can be met by mark sense cards or time shared systems now have a place to turn to for integrated hardware and software.

Reviewed by Frank J. Derfler Jr., 99-1440 Aiea Heights Dr., #25, Aiea, HI 96701.

**SAM76: the first LANGUAGE manual**  
By SAM76, Inc.  
Box 257 RR1  
Pennington, NJ 08534  
200 pp. \$12.00

In the summer of 1971, in a barn, in the township of Hopewell, in the state of New Jersey, a group of 10 to 18 year old students began an exploration of an unknown distant territory that they later called the Land of SAM. In this land there lived incredible creatures and beasties such as The Palma (text area) beast, The Stringere (string beasts) and the dreadful Translatus Uggligh (eval beast). The barn master (Claude Kagan) encouraged the students to ignore both the fearsome qualities of the creatures and anything that the students may have been told about their own inability to explore this land. So armed, with ice cream and enthusiasm, the students began to mount expeditions into the Land of SAM; to catalog, document and discover the range and powers of the creatures that lived within this country.

Seven years later, the results of these expeditions are chronicled in an easy to read, fun to read handbook of a powerful language that has been designed for you and your personal computer.

The handbook presents the syntax and discussions for at least 150 functions that are available within the SAM76 language. The naturalness of the language is highlighted along with some intrinsic features such as how the language makes no distinction between data and procedures. SAM76 is specified as an interpretive string processor and when a string of data is found to be a procedure, that procedure is immediately implemented.

Examples are included that demonstrate both the simplicity of using the language and its great power. A simulation of APL is presented along with several games and suggestions for how the language can implement recursive procedures. A complete Beastiary of the Land of SAM is recorded in the handbook with student drawings of the beasts that were encountered. The students were also the principal authors of the text. (We will print parts of the Beastiary in another issue.)

Although the book is called a manual and the main sections of the book are referred to as lessons, Mr. Kagan cautions that the book was not intended or de-

signed to teach. Rather it is a demonstration of the capabilities of the authors and is meant to encourage learning in those areas that educators too often consider to be beyond a student's range of abilities. The SAM76 manual is a powerful statement of what can happen when people (no matter what their ages) and computers are creatively allowed to be together.

Reviewed by Ramon M. Zamora.  
Menlo Park, CA

**THE RECREATIONAL PROGRAMMER**  
Volume 1, Number 1, Sept-Oct 1978  
Programmers Publishing Co.  
P.O. Box 2571  
Kalamazoo, MI 49003  
\$12/year US (\$15 elsewhere)

This new entry into the field of personal computing literature presents a well balanced first issue. The calculator games, CONCEPT and THE MEMORY GAME, that are in this charter issue are

fascinating. (Look for TRS-80 versions of these games in this issue of RC.) The applications programs that are included cover the subjects of celestial sight reduction (establishing where you are by the stars) and cryptography. There is a column dedicated to business programming ideas and algorithms.

A small reservation about the first issue is that it deals entirely with calculator routines. However, each article contains a flow diagram in words that are patterned after a BASIC program. The flow diagrams are expanded into English and are quite easy to understand and translate to a home computer system.

The *Recreational Programmer* solicits material for publication and provides yet another communications outlet for the growing body of personal computer users. *Recreational Programmer* is a welcome addition to the expanding number of leisure computing periodicals.

Reviewed by Ramon M. Zamora  
Menlo Park, CA

# TRS-80: CONCEPT GAME

BY RAMON M. ZAMORA

The game of CONCEPT was described in the charter issue of *The Recreational Programmer*, Vol. 1, No. 1, 1978. The game, created by Mordecai Schwartz as a calculator routine, is recreated here in Level II BASIC for the TRS-80.

CONCEPT can be played as a multi-person competitive game with the computer being used as a gamemaster. The game is defined around five logical concepts—parity, balance, majority, closure and skip. The concepts are applied over all the possible seven-digit binary numbers (0000000 to 1111111). The goal is to identify the valid binary numbers that totally satisfy a random set of concept conditions. The concept conditions are either satisfied or not (on/off-yes/no). A unique set of binary numbers correspond to a particular set of concept conditions. The following two tables provide examples of each concept and the suggested rules for scoring a game.

## CONCEPTS

**PARITY:** Even number of 1's.  
*Example*—1011010

**BALANCE:** Same number of 1's on each side of the middle digit.  
*Example*—1010011

**MAJORITY:** More 1's than 0's.  
*Example*—1110011

**CLOSURE:** First and last digit are the same.  
*Example*—0100110

**SKIP:** "101" pattern somewhere in the line.  
*Example*—0101011

## SCORING RULES

- (1) Each valid line that is identified—1 Point.
- (2) If only two lines exist each worth—2 Points.
- (3) If only one line exists it is worth—3 Points.
- (4) First player to correctly claim that no valid line exists scores—5 Points.
- (5) Incorrect claim in (4) above, reduce player's score by—Points.
- (6) 11 Points wins the game!

The use of a timer or clock to establish the beginning and ending of a round is recommended. Using about one minute per round keeps the game lively and active for the participants. The game is a real challenge in that it requires a player to handle several concepts at the same time. It encourages clear, logical thinking.

As you play the game, record the concept conditions where *no* valid binary lines exist. Send them to us and we will publish them. Or even better, why don't you re-write the program and have it discover all the conditions where there are no valid lines. Send the programs to us and we will publish a few with the earliest postmarks.

In the original program description there was a test loop that allowed the user to input binary lines. The program would then play back the concepts that the line satisfied. I have not implemented this feature in the current version. However, I have included the subprogram (lines 1000-1020) that is useful if anyone does wish to add a test routine. The subprogram takes the seven digit number in the variable L and disassembles it into the array D. In the current program the routine is only executed once for L equal to zero. This operation automatically clears the array.

On BALANCE, I think I have achieved PARITY in the communication of this CONCEPT and that it is time to SKIP the MAJORITY of my remaining thoughts and seek CLOSURE at this point. □

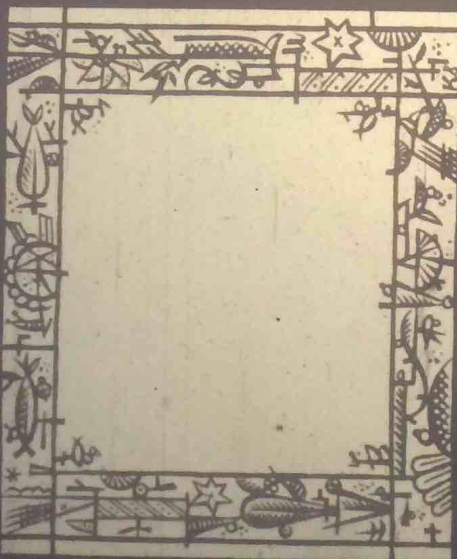

```

90 REM ** CONCEPT: BASED ON CALCULATOR GAME BY MORDECAI SCHWARTZ **
92 REM ** FROM RECREATIONAL PROGRAMMER VOL 1 NO 1 1978 PP 8-10 **
94 REM ** PROGRAMMED LEVEL II BASIC TRS-80 BY RAMON ZAMORA 10/78 **
110 CLS:PRINT CHR$(23):PRINT"WELCOME TO THE GAME OF CONCEPT"
115 PRINT"HIT THE ENTER KEY TO SEE"
116 PRINT"THE FIRST SET OF CONCEPTS":INPUT A#
120 DIM D(7),Y$(1):Z$(0)="NO":Z$(1)="YES"
130 DEFDBL L
150 CLS:PRINT CHR$(23):P=RND(2)-1
160 PRINT "PARITY EQUALS: ";Z$(P)
170 B=RND(2)-1:PRINT "BALANCE EQUALS: ";Z$(B)
180 M=RND(2)-1:PRINT "MAJORITY EQUALS: ";Z$(M)
190 C=RND(2)-1:PRINT "CLOSURE EQUALS: ";Z$(C)
200 S=RND(2)-1:PRINT "SKIP EQUALS: ";Z$(S)
205 PRINT
210 PRINT "NOW FIND THE LINES THAT SATISFY THESE CONCEPTS "
220 PRINT "HIT THE ENTER KEY WHEN YOU WISH"
230 PRINT "THE COMPUTER TO DISPLAY THE"
240 PRINT "VALID LINES. ";:INPUT A#
300 Z=0:L=0:GOSUB 1000
310 GOSUB 1100
320 IF ROP THEN 500
330 GOSUB 1200
340 IF ROB THEN 500
350 GOSUB 1300
360 IF RCM THEN 500
370 GOSUB 1400
380 IF ROC THEN 500
390 GOSUB 1500
400 IF ROS THEN 500
410 GOSUB 1600
415 Z=Z+1
420 PRINT Z,INT(L)
440 IF Z-10*INT(Z/10)<>0 THEN 500
450 PRINT "HIT ENTER KEY TO CONTINUE LIST"
460 INPUT A#
500 X=7
510 D(X)=D(X)+1
520 IF D(X)<2 THEN 310
530 D(X)=0
540 X=X-1:IF X<0 THEN 510
550 PRINT Z," LINES"
560 PRINT "ANOTHER SET OF CONCEPTS(Y/N)":
570 A#="INKEY$:IFA#="" THEN 570
575 PRINT
580 IF A#="Y" THEN 150
585 PRINT
590 PRINT "BYE FOR NOW!!":END
1000 X=7
1010 D(X)=10*(L/10-INT(L/10))
1015 L=INT(L/10):X=X-1
1020 IF X<0 THEN 1010 ELSE RETURN
1100 T=0:R=0
1110 FOR X=1 TO 7:T=T+D(X):NEXT
1115 IF T=0 THEN RETURN
1120 R=2*((T+1)/2-INT((T+1)/2))
1125 RETURN
1200 R=0:T1=D(1)+D(2)+D(3):T2=D(5)+D(6)+D(7)
1205 IF T1+T2=0 THEN RETURN
1210 IF T1=T2 THEN R=1
1215 RETURN
1300 R=0:T=0:FOR X=1 TO 7:T=T+D(X):NEXT
1310 IF T<3 THEN R=1
1315 RETURN
1400 R=0:IF D(1)=D(7) THEN R=1
1410 RETURN
1500 R=0:X=1
1505 GOSUB 1550
1510 IF R=1 THEN RETURN
1515 X=X+1
1520 IF X>5 THEN RETURN
1525 GOTO1505
1550 IF D(X)<1 THEN RETURN
1560 IF D(X+1)<1 THEN RETURN
1570 IF D(X+2)<1 THEN RETURN
1580 R=1: RETURN
1600 L=0:X=7:R=0
1610 L=L+D(X)+10↑R
1620 R=R+1:X=X-1:IF X<0 THEN 1610
1630 RETURN

```

Develop a set of concepts

Check that line satisfies all concepts

Print the valid lines

Stop every 10 lines

Generate next line to be checked

Check for end of session

Disassemble subprogram. Sets D(X) to zero first time through. Can be used if a test loop is added to program. PARITY subprogram

BALANCE subprogram

MAJORITY subprogram

CLOSURE subprogram

SKIP subprograms

Assemble the seven digit number from the D(X) components

# SPOT

The Society of PET Owners and Trainers

EDITED BY HARRY SAAL

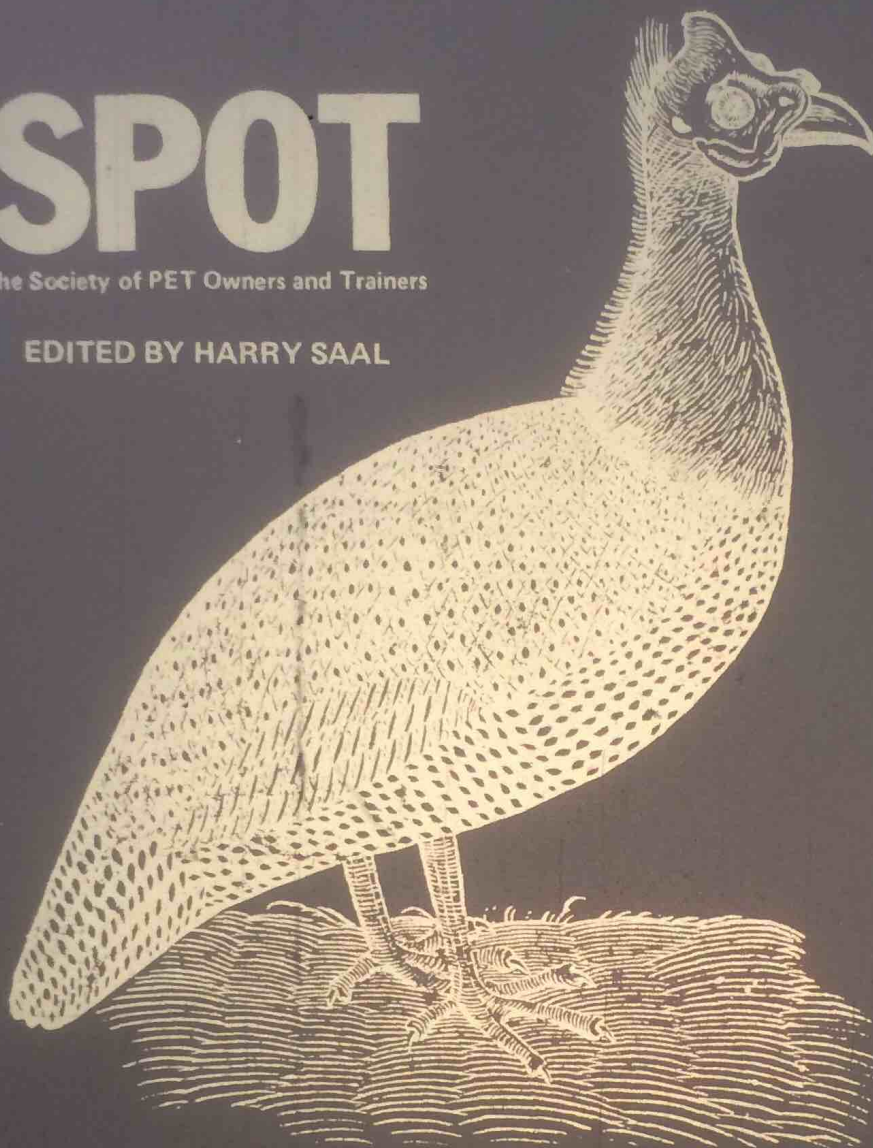

## HEARD AROUND THE QUAYSIDE . . .

Traffic has been heavy through the revolving door at Commodore Business Machines lately. New faces have arrived as part of a restructuring of the U.S. consumer marketing operation. *Electronic News* reports that Commodore now has Tom Mitchell serving as general manager, Dennis Barnhart as vice president of marketing for consumer products, and Jim Kennedy as vice president of technology. Hugh Getty is vice president of computer marketing, with G.M. O'Neil serving as director of marketing and sales of personal computers. Also of note are the recent departures of three important members of the PET team: Chuck Peddle, father of the PET (and the 6502 microprocessor used in it), who is now with Apple Computers; Bob Skyles, in charge of all PET engineering; and Li-Chen Wang, in charge of the PET floppy disk project.

PET production is definitely up, with a new factory in Clearlake, Iowa, shipping machines at a ferocious pace, and one in England getting on the air shortly. All the same, it still appears that Commodore's marketing emphasis is overseas, where profit margins are substantially higher than stateside. Support seems superior there, too, with Commodore providing very interesting newsletters and bulletins in England, Canada, and Japan. PET optimists are hoping that the management shifts reported above will result in superior service and credibility in the U.S. arena.

On that note, we *did* receive a down payment on the long-awaited information due to each PET owner. Yes, Virginia, there is a Machine Language Monitor tape, with two BASIC programs on the flip side. SQUIGGLE is an example of graphic art on the PET, with BIGTIME displaying the time of day in giant numbers on the screen. A brief manual accompanies the tape. The package did not include the promised BASIC manual, which is certainly the most missed by a new PET owner. (Have you seen the documentation given out by Apple?) But there was a bonus manual entitled "PET Communication with the outside world." Those of you who want to learn more about the user port, memory expansion interface, the IEEE-488 bus, or about data file operations from BASIC will find a wealth of information in this manual. It is honest enough to describe some of the outstand-

Commodore's PET is a factory assembled personal computer based on a 6502 microprocessor. The \$795 system includes a keyboard, cassette tape unit, built-in TV screen, some graphics, upper and lower case, and extended 8K BASIC, and 8K of user memory.

Our readers' enthusiastic response to the PET has resulted in "SPOT," one of the magazine's most popular regular features. The column was started, produced, and lovingly nourished by former People's Computers editor Phyllis Cole. With this issue, she relinquishes the project to Dr. Harry Saal of Palo Alto, Calif.

Twenty years ago, as a high school student in Brooklyn, the only way Harry could get his hands on a computer was to make a pest of himself at IBM's World

Trade Headquarters and Watson Lab, getting five-minute shots on a 650, writing programs in biquinary. Today he has to negotiate machine access with his eight-year-old daughter and six-year-old son, who occasionally permit Dad to use the PET. Harry's been professionally involved in microprogramming and microcomputers since about 1970, as both a researcher and professor of computer science. He has spent the past few years working on the design of APL systems for IBM.

In Harry's view, the purpose of this column is to bring readers information on the PET that would be otherwise unavailable. He wants to hear about problems you haven't solved as well as those you have. So keep those notes and comments coming. — LB



ing bugs in this area, and some temporary fixes. Let's hope the BASIC manual is as complete as this one is!

Of course, a little survey showed that most of the PET owners I spoke to had not received these goodies yet. It seems that distribution is up to the dealer from whom you purchased your PET, so contact him or her. And if you bought it from Commodore directly, but didn't send in your warranty card (which is optional), your name isn't on the mailing list. By writing a letter to the dealer from whom you purchased your machine you can be sure to receive this mailing and future ones.

Also available from Commodore is the PET Service Kit, for \$31.95. It is meant for the experienced electronic technician, and includes schematic diagrams and parts lists for the PET. It also contains a diagnostic jumper connector, which enables the built-in PET diagnostics. A cassette tape comes with a batch of programs used to verify ROM and RAM memory operations, tape cassettes, etc. Note that quite a bit of the PET must be working before you can even run (or load) these tests, and the Kit assumes that the service man can figure out what part needs replacing, once the general problem area has been narrowed down.

## PET PROBLEMS

A number of readers seem a bit confused about the so-called "lost cursor fix." Of the PET's several common software problems, this is the only one for which Commodore has made a fix available in ROM. The problem occurs during editing of BASIC programs, when statements are being shuffled around in memory. The symptom is that after hitting RETURN, the cursor stops winking, and the only way to recover is to turn the PET off, then back on, losing memory contents in the process. Commodore (see your dealer again) will supply a new ROM to replace the old one for \$15. The new part is called the 019 ROM, and replaces an 012 ROM in position H1 (rightmost ROM) on the circuit board. Because early PETs used 6540-type ROMs, and later ones use 2316B-type ROMs, which have different numbers of pins on the integrated circuit from each other, confusion has ensued.

Also keep in mind that many hardware problems can cause the same symptoms

as this software problem. Bad RAM, a flakey ROM, and who-knows-what could all leave you sitting with a PET which has stopped flashing its cursor. For example, Carl Bach of Garland, Texas, wrote to tell us that he traced many failures of his PET to line voltage transients in his power lines. He installed a power line filter (he used the J. W. Miller 5 section L/C filter Model C-509-L) and instead of losing his cursor three or four times a day, it now happens only every other week or so.

One problem that never goes away is the alignment of the cassette tape head. Eventually it will shift, and need adjustment. In a digital system it can't be ignored, as it can in audio usage. Readjusting it is a delicate job, but those of you with a mechanical inclination might prefer to try and do it yourself instead of sending your PET away to the vet for a few weeks. Many thanks to writer Grant Paul and editor Gene Beals, of *PET User Notes*, Box 371, Montgomeryville, PA 18936, for permission to reprint the following article:



## HEAD ALIGNMENT FOR THE PET

The drive mechanism of the PET's tape unit is similar to those found in inexpensive audio cassette recorders and is not particularly noted for its ruggedness. This mechanism, including the tape heads, takes a lot of mechanical abuse from frequent starts, stops, rewinds, etc. After a period of time, it is possible for the record/play head to go out of alignment (particularly if the original adjustment was set marginally at the factory), causing read errors to develop. The alignment of the tape head is usually quite critical and normally requires the use of a test tape along with an oscilloscope (or meter); however, the technique described below can be used with excellent results and without the use of any specialized equipment (other than the PET itself).

First and foremost, make sure your tape heads and capstan are clean, and that the heads have been properly demagnetized. Second, load in a program (preferably a lengthy one) which was recorded on a quality cassette tape. After loading, PEEK at memory location 630, i.e. PRINT PEEK (630). The value returned by the PET divided by 2 gives the number of dropouts encountered in reading the tape. Ideally, this number is zero (and frequently is), but an occasional low number is probably all right. A consistently high number, on the other hand, is an indication of a problem. There are several possibilities for excessively high dropouts, which include using a defective or poor quality cassette (try loading programs from other tapes), mechanical slippage (make sure the drive belt, idler wheels, and capstan are clean), and faulty electronics; however, the chances are quite good that the record/play head is out of alignment.

To realign the head, first turn off the PET and remove the cassette recorder from the unit. Disassemble the top and bottom halves of the recorder's plastic case and remove the mechanism. The record/play head (which is located to the right of the erase head) is now fully accessible. Upon examination, you will note that this head is held down by two small screws. The screw to the left, which is spring loaded, is the alignment screw, and the one you will be adjusting.

The alignment procedure can be performed relatively easily using the following steps:

1. With a toothpick and some paint or nail polish, carefully mark one dot on the head of the alignment screw and another dot next to it. These markings serve as a reference point when turning the screw.
2. Connect the tape recorder cable to the main circuit board of the PET and turn the unit on.
3. Load in a program and PEEK at memory location 630. Note the number of dropouts.
4. Now, with a small non-magnetic screwdriver, carefully rotate the adjusting screw 1/16 of a turn.

5. Reload the program and note the number of dropouts. If the dropouts increased significantly, the adjusting screw was turned in the wrong direction.
6. Repeat steps 4 and 5 until the number of dropouts is reduced to zero (or to a low level). The final screw adjustment usually does not require more than 1/8 of a turn from the original position.
7. Before reassembling the unit, try loading programs from several other tapes to make sure everything is working properly.

The entire head alignment process for my PET's tape recorder took approximately 30 minutes, and I am once again able to read tapes with excellent reliability.

#### THE PET AND ITS COUSINS

You may not know that the PET is part of a large family of computers which use the same microprocessor chip. That means that software developed for one member of this family can usually be converted fairly easily to work on other similar machines. This includes the Apple II, MOS Technology's KIM-1, Syneretek's SYM-1, products from Ohio Scientific (OSI), Rockwell, and even Atari. If you'd like to know about what people are doing with their 6502-based systems, one good source of information is *MICRO*, published bimonthly by The Computerist, Inc., P.O. Box 3, So. Chelmsford, MA 01824. A subscription is \$6/year. It is in its second year of publication, and will soon publish *The Best of MICRO* for those who missed the early issues.

#### RENUMBERING PET BASIC PROGRAMS

A really excellent program for renumbering BASIC programs was developed by Bill Seiler of Palo Alto, Ca. It is written in machine language, and occupies only 384 bytes of memory at the high end of an 8K PET. It will renumber both the line numbers and all references to line numbers in a program. Bill's program will handle up to 512 line programs at most (have you written a bigger one?), and uses a clever trick to save on memory space needed. It uses the screen memory as a place to keep its table of correspon-

dence from old to new line numbers, thus avoiding the need for one thousand bytes of data area. Once you have loaded it in, and POKEd the appropriate pointers, it will stay in the machine until you turn it off. Copies of the program are available through *PET User Notes*, P.O. Box 371, Montgomeryville, PA 18936. Request a copy of PET RENUMBER by Bill Seiler, and include \$2 for the copying service and tape.

#### ON READING PROGRAMS

With so many programs available for the PET, and so little documentation on PET BASIC and the various tricks that can be played with PEEKs and POKEs, take some time out to "read" your favorite PET program. It is often like archaeological field work—rummaging around in the ruins of a once elegant culture and discovering little tidbits that can be quite illuminating. If you want to learn about some of the more unusual statements in BASIC, or graphic animation, or space-saving tricks, really studying a program can teach you a lot. Once you feel comfortable "browsing" through someone else's program, go ahead and try to change it. Add a new option, or make it more fool-proof against incorrect inputs. Take a program that uses the screen as a teletype and animate it. The PET's screen editor makes the mechanics of modification simple, allowing you to concentrate on new features.



I must admit that I haven't seen many programs which I would recommend as models of programming "style," but would be happy to print some in this column. Send any candidates you have to the SPOT Editor.

#### PET TIPS

If you are editing a line on the screen, and are really fouled up...stuck in quote mode...just press SHIFT and RETURN. The cursor will go on to the next line WITHOUT having entered the changes so far. Now you can reLIST the line and start editing again.

NEVER use GET with a numeric argument, i.e. GET A. If the user types a non-numeric key a SYNTAX ERROR message appears and the program ends up in READY. Use GET AS, and then check AS for legal characters. You can then convert to numeric form using VAL(AS), for example.

The PET keeps a buffer of keys that have been pressed but not read yet by a program. This can often give funny behavior when users type a RETURN that the program didn't expect, etc. A simple way to avoid some of these problems is to flush out any key depressions which are buffered up in the PET just prior to requesting input. One simple way to do it is by a loop like FOR XX=1 to 9: GET XX\$: NEXT. A more obscure way for those who know the PET-innards is to simply POKE 525,0.

## PET PRODUCTS

### THE CHANNEL DATA BOOK

An excellent reference book on PET product information is the *Channel Data Book*, just published by Channel Data Systems, 5960 Mandarin Avenue, Goleta, Ca 93017. Issued in three-ring binder format for easy insertion of new information and updates, it is the most extensive collection of PET-related product information available to date. The initial purchase price of \$20 includes the *Data Book* and update service for one year. A major annual update will be published in the first quarter of each new year, with the supplement published at least quarterly. The book can help you find special purpose hardware attachments for your PET, programs of interest, and also has lists of PET-related publications, User Groups and even PET dealers.

### APPLICATIONS RESEARCH PRO-CAL-1

Applications Research Co., 13460 Robleda Rd., Los Altos Hills, CA 94022, has developed a reverse polish programmable scientific calculator program. It combines features of hand-held and desktop calculators such as the TI Programmer and HP 97. Calculations may be done in binary, octal, decimal or hexadecimal, and all conversions are available. Ten memory locations, five stack registers, and a record of the 14 most recent operations are displayed. Programs of up to 255 steps may be entered, and saved or loaded from cassette tapes. The program and documentation costs \$26 from Applications Research.

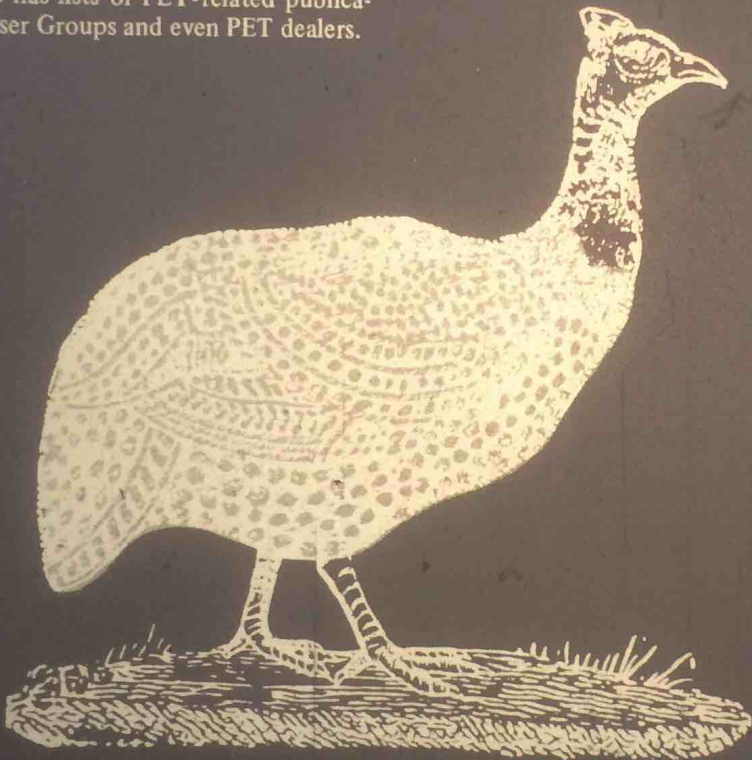

### GRI PERK™ KEYBOARD

George Risk Industries, Inc., GRI Plaza, Kimball NB 69145, is now offering a full size typewriter-style alphanumeric keyboard for the PET. It is housed in its own steel enclosure, and operates in parallel with the built-in keyboard. It is assembled, and contains its own power supply and interface card. The introductory price is \$229.95, with a 90-day warranty.

### COMPUTHINK DUAL MINIFLOPPY DISKS

Computhink, 701 Welsh Road, Palo Alto, CA 94304, has a dual minifloppy disk system for the PET. The system contains two diskette drives, each capable of addressing 100K bytes of storage at a time. It comes completely assembled and tested, and includes a disk controller which plugs into one of the peripheral expansion slots of the Expandapet

memory expansion system, which is also available from Computhink. The system will support up to four diskette drives, and a parallel printer interfaced via the PET user port. The Operating System software is contained in ROM, and is included with the disk controller. The software provides an additional 16 commands to PET BASIC, such as \$SAVE, \$DIR, \$OPEN, etc. The cost of the dual diskette system is \$1295, in addition to the required Expandapet (from \$425). A source listing of the Operating System code will be available for \$20. Computhink also is offering a number of useful programs for the PET (with or without disks). They include a machine language assembler, editor and linker system, along with a useful guide to machine language programs running on the PET. (We'll try and get a review of the disk system and software for a future issue.)

### NESTAR SYSTEMS, INC. CLUSTER/ONE™

Nestar Systems, Inc., 810 Garland Drive, Palo Alto, CA 94303, has used the PET as part of Cluster/One, a low-cost distributed processing alternative to BASIC timesharing. A Cluster/One system can be configured with up to 15 PETs (or Apple IIs) connected via a high speed parallel data bus (the Cluster/Bus™) to a central PET. Each user has his own computer, and does not share the central processor, except for access to program file storage, or printer output. Programs are stored on two IBM-compatible eight-inch flexible disks, with up to 1.2 million bytes available on-line. Cluster/One was designed to be a highly reliable, simple system to use in the classroom or program development environment. Cluster/One prices begin at \$7500, and vary with the particular configuration and options selected. (Note: *Recreational Computing* will have a report in the next issue on a symposium on "Personal Computers in Education"; the Cluster/One and other microcomputer offerings will be discussed in that article.) □



# 10 REM—Art Review

At times, computers are said to generate art (graphic forms, textile design patterns). At times, artists (engineering artists, design artists, software artists—yes, there is art involved) generate computers. Once in a while a quiet synthesis occurs when a person working in the area of the fine arts and information from a computer program are joined together.

A show called "Visions of Flight," installed from the end of October to mid-November in the Gallery House of Palo Alto, California, contained such a point of synthesis. Judith Wasserman (RC's own Judith Wasserman) in her section of the show, subtitled "Voyage to Antares," displayed a series of relief etchings derived from the output of a computer program. The program, written by Robert Burt, generated the star configurations that would be observed if one were to travel along a line from our sun to Antares.

For the show, points along this space path at 10, 50, 200 and 500 light years were selected. Haunting views, as seen from a spacecraft's window, fill each print. The cold blackness of space; the bright points of light that represent the stars; the faint yellows, oranges and reds of distant suns. And then, embossed in white across the surface of the prints, renderings of mythic creatures formed of star points and dark voids. *The Bearded Bull of Canopus*; *The Great Octopus of Antares* hang in space 500 light years from here. *The Horned Cats of Hadar*; *The Serpent of Spica* prowl the stars 50 light years away. In all there are fifteen creature/myths portrayed. In the words of the artist they represent "an expansion of earthbound mythology into a future time and space . . ."

It is joyful to see and experience this creative marriage of technology and spirit; of data and insight. The question arises as to who else and where else is this being done.

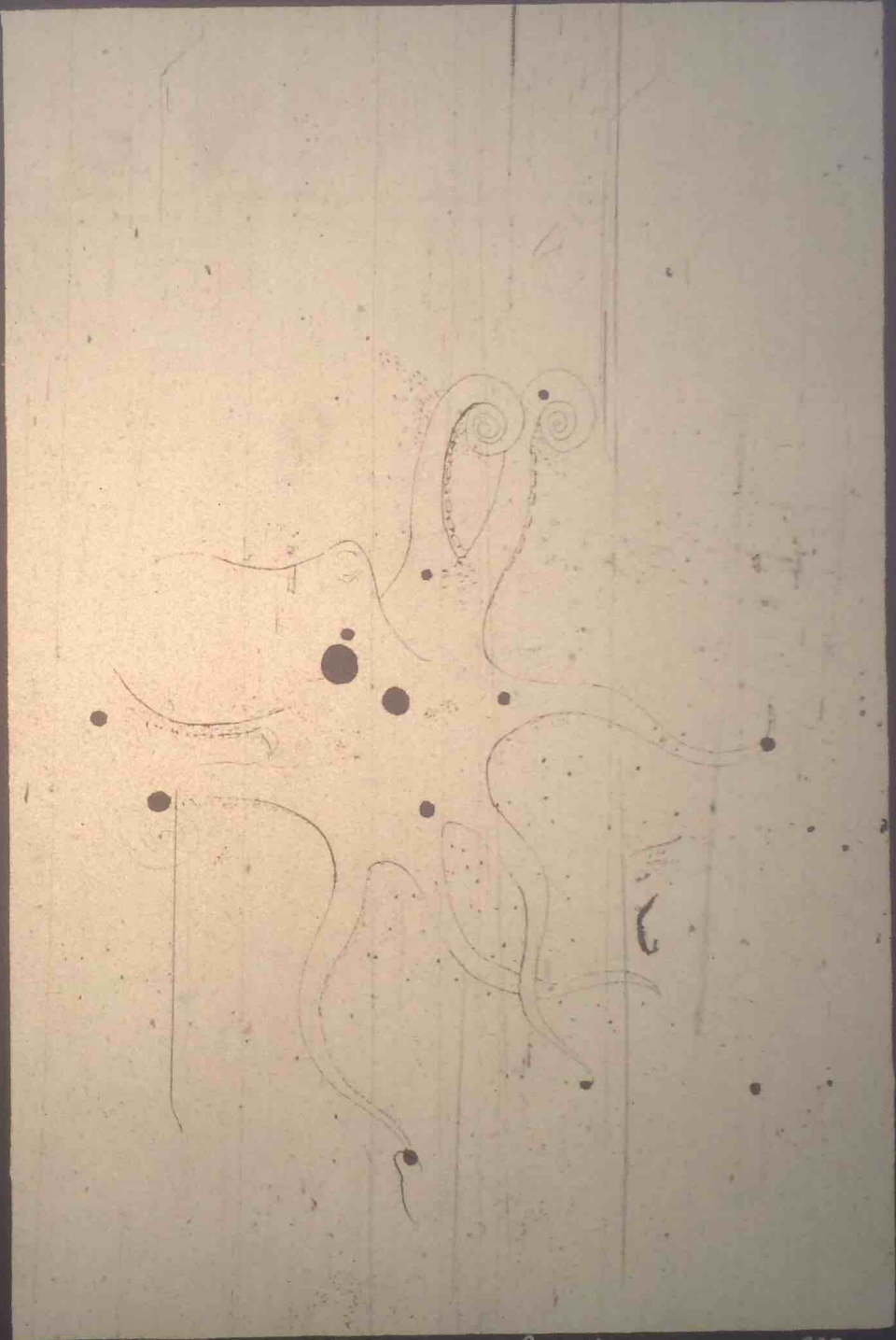

*The Great Octopus of Antares*

© Judith Wasserman 1978

Reviewed by Ramon Zamora. □

# Announcements

Edited By LeRoy Finkel

*The items in this section are culled from the many press releases and product announcements we receive each day. While some selections are based on the whim of this editor, most are chosen for their interest to our readers, namely recreational and home applications. The words are those of the news source, slightly edited. The inclusion of an announcement does not constitute an endorsement by People's Computer Company, merely a posting of timely information. —LF*

## Hardware

### NEW TERMINAL SYSTEM FROM SWTPC

Southwest Technical Products announces a terminal system that will work with almost any modem or computer system interfaced RS-232 serially from 50 thru 38,400 baud.

Designated the CT-82, the terminal features over 100 control functions operable from either the CT-82's keyboard or the computer's program. With its low price and graphics capability, it's ideal for business or hobby use. The terminal design utilizes a Motorola 6802 microprocessor and 6845 CRT controller integrated into a modular system which is simple, reliable and easy to service.

The CT-82 is offered in assembled form only and sells for \$795. ppd. in the continental U.S. Write for complete details: Southwest Technical Products Corporation, 219 W. Rhapsody, San Antonio, Texas 78216.



### MATSUSHITA ANNOUNCES HOME AMUSEMENT TV SYSTEM

Matsushita Electric Industrial Co. has developed an innovational video signal processing device which makes it possible to record and reproduce both sound and pictures using a standard audio cassette tape recorder and a color TV receiver.

The new color TV application prototype, dubbed Home Amusement Television System, has opened up a new field for a home color TV. It will no longer be a mere receiver of broadcasted TV programs, a Matsushita spokesman said.

The system features an easy recording process by which a user can produce his own programs at home using either a keyboard or a light pen.

The new system consists of a video signal processor, an input keyboard, a color TV receiver and a stereo cassette tape deck. The video signal processor, specially developed for the system, is used for recording and playing back the video signals from the cassette tape.

Utilizing the keyboard, a user can make a program in words and/or pictures, monitoring the results on the color TV screen. An audio track for music or narration can be recorded at the same time.

Approximately 350 frames of pictures with sound can be recorded on an ordinary 60-minute cassette tape, the developer says.

The number of picture elements available is 192 x 256 dots for monochrome character displays and 96 x 128 dots for color pattern drawings. Seven different colors are available—red, blue, green, yellow, cyan, magenta and white.

Details for the marketing of the prototype will be determined after the company studies the opinions and requirements of the software manufacturers as well as the customers. However, it will be available within a year.

### SORCERER COMPUTER SYSTEM (Reviewed in PC Vol 7, No 2)

The Sorcerer Computer introduces a new concept in user-programmable computers. This self-contained unit needs only to be plugged into a video display and a cassette tape recorder to be a fully functional computer system which can be expanded in a number of directions.

The Sorcerer's tape cartridge acts as a removable "chunk" of memory that can hold up to 16K of Read Only Memory for storage of "permanent" software. This means the user is not restricted to any one language. This unique ROM PAC™ cartridge may contain high level languages, operating systems, and special priority software.

User defined graphic symbols allow you to be creative in symbols and graphic forms, including foreign language or even new computer language symbols. The Sorcerer's 512 x 240 graphics offer high resolution pictures and add a new dimension to your programming.

Standard features include: Z80 Processor; 63-key typewriter-style keyboard and 16-key numerical pad; interfacing for standard I/O equipment; 8K RAM (expandable to 32K); 4K ROM operating system; 8K ROM Microsoft BASIC in ROM PAC™; 128 user-defined graphic symbols. Sorcerer prices begin at \$1,279. Available from your local computer store.

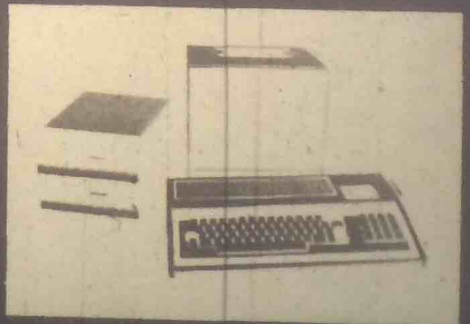

# Software

## NEW PUBLICATION DEDICATED TO SOFTWARE

*The Software Exchange* is a new publication devoted to the exchange of ready-to-use software for business and the home.

Each issue of *The Software Exchange* has reviews and articles about microcomputer software. In addition, classified advertising space is provided for computer software. You can match your application and computer to those listed. Each program has a description of its operation, hardware requirements, and where the provided materials can be obtained. If you have a special program you need, you can place a free "Wanted" ad in *The Software Exchange*.

*The Software Exchange* is a bimonthly magazine available at computer stores for \$1 per issue and by subscription for \$5 per year (six issues). For air mail service to Canada or Mexico, add \$4. Subscriptions to other foreign countries are \$19 (air mail service). Send inquiries and subscriptions to: The Software Exchange, Box 55056, Valencia, CA 91355.

## COMPUTER CASSETTES CATALOGUED

Everyone seems to be writing programs for the TRS-80, the PET, and the Apple II. There are so many cassettes for these computers that you need a computerized reference list to keep track of them all.

Robert Elliott Purser has a list of more than 1,000 cassettes for sale or trade from some 100 sources. The list is published quarterly, with every issue seeming to double in size. The February '79 edition will include photographs of the computer's display screen for some of the programs so you can see what the program will do on your computer.

If you have original software for sale or trade for these three computers, send a list of your cassettes to Purser.

To receive this computer cassette reference list every quarter, send \$12 for a one year's subscription or \$4 for a single copy to: Robert Elliott Purser, P.O. Box 466, El Dorado, CA 94623.

## TRS-80 PILOT IS HERE!

PILOT is the computer language of the future for computer-assisted education. It's so simple even six-year-olds have taught themselves to write imaginative programs in PILOT.

TRS-80 PILOT is a program development package using the Program Statements T, A, M, U, C and E, as well as the special TRS-80 statements S (to clear the screen) and P (to use TRS-80 Graphics). Commands supported are CLOAD, CSAVE, RUN, EDIT, LIST and NEW. In addition, users of complete TRS-80 systems may modify for LOAD and SAVE, LLIST and L (the lineprinter equivalent of T; prints to the line printer), using easy-to-follow instructions.

TRS-80 PILOT is available for \$50 from Jeff Lasman, P.O. Box 4139, Foster City, CA 94404 (California residents please add proper tax). A sample PILOT program and complete documentation are included. TRS-80 PILOT requires Level II and can work in systems as small as 4K.

## VIDEO CHECKERS FOR TRS-80 AND PET

Compu-Quote of Canoga Park, California, has converted its popular VIDEO CHECKERS to run on the TRS-80 and the Commodore PET. The two new cassette versions each produce complete checkerboard graphics.

The challenging game is played conforming to international rules. As the player and the computer take turns, the checkers blink and move to indicate their passage. Kinged pieces are identified on the display, and messages appear at the right of the board relating to each move. In accordance with international rules of the game, the program will not accept illegal moves and warns of their entry.

The PET version will play on any 8K machine, while the TRS-80 version requires Level II BASIC and 16K. Complete operating instructions are included with each redundantly recorded cassette.

VIDEO CHECKERS may be ordered for \$14.95 from Compu-Quote, 6914 Berquist Ave., Canoga Park, CA 91307. Be sure to specify which version—PET or TRS-80—is desired.

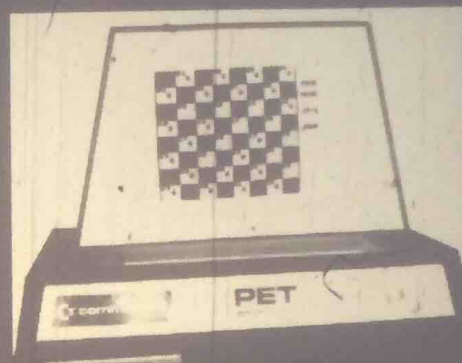

## CHESS FOR PET, TRS-80, APPLE

MICROCHESS is the culmination of two years of chess-playing program development by Peter Jennings, author of the famous 1K byte chess program for the KIM-1. MICROCHESS 2.0 for 8K PETs and 16K Apples, in 6502 machine language, offers eight levels of play to suit everyone from the beginner learning chess to the serious player. It examines positions as many as six moves ahead, and includes a chess clock for tournament play.

MICROCHESS 1.5 for 4K TRS-80s, in Z-80 machine language, offers three levels of play. Both Level I and Level II versions are included and can be loaded on any TRS-80 without T-BUG. MICROCHESS checks every move for legality and displays the current position on a graphic chessboard. You can play White or Black, set up and play from special board positions, or even watch the computer play against itself! MICROCHESS is available at an introductory price of \$19.95 from authorized dealers worldwide or by mail from Personal Software, P.O. Box 136, Cambridge, MA 02138, (617) 783-0694.

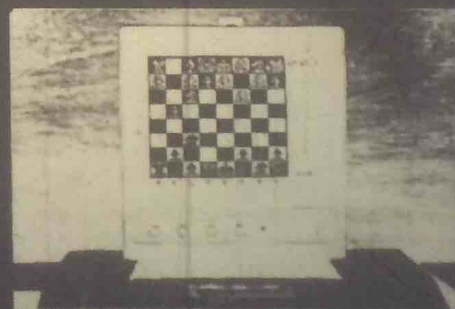

## SOFTWARE FOR JEWISH STUDIES

Experienced educators have developed the following Jewish study programs for the TRS-80:

**CHUMASH:** Parshat Hashavua: A thorough review of each week's Sidra, suitable for use in all grades 4-8. Each Parsha contains 3 cassettes and a teacher's manual with resource material. (Bereshit-Mishpatim currently available) \$10/Parsha

**CHAGIM:** Rosh Hashana: Major topics of the Holiday are stressed in this highly exciting program. Suitable for use in day schools (grades 4-8) and in Congregational schools. Included with the 3 cassettes is a teacher's manual, containing many suggested strategies for use in the classroom. \$10/each

**TEFILLAH:** Kriat Sh'ma: An excellent institutional program on the Kriat Sh'ma as a unit of prayer. Teacher's manual contains background material on several of the main themes in Kriat Sh'ma. Suitable for use in day schools and in Talmud Torahs. \$10/each

Available from: Dr. Samuel Spero, Director, ICJL, Hebrew Theological College, 7135 N. Carpenter Road, Skokie, IL 60077.

## WORD PROCESSOR

WORD is a powerful text processor on the Radio Shack's TRS-80 system. It accepts lines of text interspersed with lines of format control information and formats the text into a displayable or printable document.

It helps the user prepare memos, documents, manuals, letters and even books. The user can make changes, insertions and deletions without retyping the whole page or pages.

WORD-I has all the basic commands; WORD-II has additional commands to process book formats; WORD-III is a diskette-based word processor.

### Features:

- automatic line filling, line feed control and margin justification
- page size, line width and indent control
- vertical spacing control
- title and sub-title control
- automatic page numbering
- multiple-column output

- text storage in more than one data cassette
- equivalent editing features provided by Level II BASIC
- "ignore text" and "skip pages" commands
- easy upgrade to WORD-II or WORD-III
- input of some commands on-line.

Available from: Micro Architect, 96 Dothan Street., Arlington, MA 02174.

## PET WORD PROCESSOR

A word processing program for your PET prepared by Connecticut Microcomputer. For home use in composing letters, flyers, advertisements, manuscripts, articles, etc. using your PET and an RS-232 printer.

Script directives include line length, left margin, centering and skip. Edit commands allow the user to insert lines, delete lines, move lines, save onto cassette, load from cassette, move up, move down, print and type. \$29.50 from Connecticut Microcomputer, 150 Pocono Road, Brookfield, CT 06804.

## HOME EDUCATIONAL PROGRAMS

Now available for TRS-80, PET and Apple II:

**Step-by-Step.** A three-cassette course that teaches you BASIC programming. \$29.95

**Preschool IQ Builder.** Tapes for tots to help them develop skills. \$9.50

Contact: Program Design, Inc., 11 Idar Court, Greenwich, CT 06830.

## TARBELL BASIC AVAILABLE

Tarbell Electronics of Carson, California, has announced the availability of Tarbell BASIC on cassette or CP/M Disk. The CP/M version is capable of disk interaction, including saving and loading programs, chaining programs, and loading data. The interpreter occupies 21K of RAM.

Most of the features of ALTAIR Extended BASIC have been implemented in Tar-

bell BASIC, and several new ones have been added. New features include assignment of I/O, long variable names, cassette string data SAVE, procedures with local variables, and alphanumeric line labels.

Additional capabilities, not found in other versions of BASIC, greatly enhance Tarbell BASIC. For instance, two statements, ASSIGN and DROP, let the user assign or de-assign as many as ten physical devices to six separate logical I/O devices. Alphanumeric line descriptors can replace normal line numbers, and the use of lengthy variable names is permitted. These features improve readability and maintenance. The use of procedures allows arguments to be passed to subroutines, and local variables may be declared to enable subroutine libraries to be developed and utilized efficiently. Subroutines may then be appended to Tarbell BASIC programs using a single command.

The I/O section listing, included in the documentation, is easily modified to suit the user's requirements. Good access to the user's machine language subroutine is facilitated by the CALL function.

Both cassette and CP/M Disk versions of Tarbell BASIC are available with complete operating manual for \$36 each. The source listing is available as a printout, or on disk, for \$25.

For complete information contact Tarbell Electronics, 950 Dovlen Place, Suite B., Carson, CA 90746; (213) 538-4251 or (213) 538-2254.

## PERSONAL LEDGER SOFTWARE NOW FOR TRS-80

Channel Data Systems' Personal Ledger is a complete double entry bookkeeping system with provisions for budgeting and keeping records of income, deductible and non-deductible expenses, assets and liabilities. Its simple interactive features enable entering transactions, adding or editing accounts, and printing of a detailed Income Statement and Balance Sheet. Users completely unfamiliar with computerized accounting and with little or no knowledge of bookkeeping can use the system.

Up to 50 accounts are allowed with names and budgets specified by the user. An audit trail of all entered transactions

is printed on the screen where it can be copied with the screen printer or copied to cassette, loaded prior to entering transactions and stored after entering transactions. There is no waiting for printing to the tape during operation of the system. Extensive error recovery features are included to allow reentry of an erroneous instruction or value.

The Personal Ledger runs in 8K bytes of free RAM on Commodore's PET and 16K bytes on Radio Shack's TRS-80 Level II. Level II BASIC is a version of Microsoft BASIC which can be translated to most other BASIC systems with minimum modifications.

Personal Ledger is supplied on cassette in TRS-80 Level II or Commodore PET format (please specify) and includes a complete manual with a program listing, flow charts, sample data, and complete operating instructions. All for only \$20 (Calif. residents please add 6% sales tax) from Channel Data Systems, 5960 Mandarin Avenue, Goleta, CA 93017, or telephone (805) 964-6695.

#### NEW PROGRAMS FOR PREPARING TAX RETURNS

TAXPAK software is designed for the hobbyist/home user to compute IRS form 1040 and up to five related schedules. Display is on video-screen with dollar amounts listed in order by form line number. This is security plus for do-it-yourself tax returns. TAXPAK retails for \$39.95.

TAXPRO software is designed for the professional tax preparer who has an 8080 microcomputer, North Star disk drive, and printer. This complete package computes IRS 1040 and thirteen related schedules and forms, using the "least tax" approach. Hardcopy prints in format on form 1040 pages 1 and 2, and prints other forms on plain paper.

The related forms and schedules are: Schedules A, B, C, D, E, G, R & RP, SE, TC; Forms 2106, 2441, 4726. Included is a user's manual and set of data input worksheets. TAXPRO retails for \$1,415.00.

To order TAXPRO and TAXPAK, write DICOMP, Box 8272, Rowland Heights, CA 91748.

#### TSC SOFTWARE CATALOG

A new catalog of microcomputer software products has been announced by Technical Systems Consultants. Dozens of assembly language programs are described, mainly for the 6800 and 8080 microprocessor. The software includes editors, assemblers, text processors, math packages, games, utilities, and more. Recreational programs include Space Voyage, Klingon Capture, Stockmarket, Battleship, Hangman, Mastermind, Chomp, and other favorites.

Most programs are sold with printed source listing and machine readable object code in the form of disk, cassette, or paper tape. Prices range from \$3.75 to \$75. For a copy of this complete catalog, send 25 cents to Technical Systems Consultants, Inc., P.O. Box 2574, West Lafayette, Indiana 47906.



#### APL/Z80

APL/Z80 is an APL interpreter for Z80 microcomputers. APL/Z80 extends APL applications to the realm of low cost personal computers. However, the power of APL/Z80 is comparable to APL on a large timesharing computer for many applications. Nearly all primitive APL functions and operators are implemented in APL/Z80. Those primitives not present are easily implemented as defined APL functions.

An APL/Z80 end-user object code license is available for \$300.00. APL/Z80 object code for Digital Group Z80 systems is available for immediate delivery. APL/Z80 running under the CPM operating system will be available in 60 days.

A complete APL/Z80 computer system is available from Vanguard Systems Corporation with the following features: APL/Z80 software; 35K byte active workspace; dual drive floppy disk system with more than 500K byte workspace and copy object library; keyboard; video display (16 lines, 64 characters). \$5995.

Printer option: 30 CPS printer with APL character set. \$2495. Vanguard Systems Corporation, 6812 San Pedro, San Antonio, TX 78216; (512) 828-0553. 828-0553.

#### PASCAL SOFTWARE

PASCAL is now available on the Alpha Micro computer system and it is free to all new and existing Alpha Micro users. PASCAL:

- Allows definition of new data types to express data meaningfully
- Provides structures with which data can be expressed clearly and naturally
- Encourages formation of logical, structural programming
- Offers systematic and modular approach to program design.

PASCAL has been accepted in many universities for several years and has been actively used on both micro and macro systems.

Available from The Computer Place, 186 Queens Street West, Toronto, Canada M5V 1Z1.

## Other

#### MAGAZINE ON CASSETTES FOR TRS-80 USERS

*Level I Magazine* is the audio magazine written for the TRS-80 computer. It is produced on a C-60 cassette, with every issue written in Level I and Level II. Its magazine-type format has a minimum of 40K of programming per side and is broken down into 16K loads.

There are 25 articles each month, ranging from product information through sports instructions to self analysis. Each issue also contains game programs, graphic displays, educational aids, and information to keep you busy for hours.

A six-month subscription to *Level I* is \$22; one-year is \$40. Normally, single issues are \$4., but the premiere issue is only \$3. For further information, write to: *Level I Magazine*, P. O. Box 8316, Anaheim, CA 92802.



## NEWSLETTER STARTED FOR APPLE II OWNERS

Subscription orders are now being accepted for *The Rainbow*, an independent user newsletter dedicated to the Apple II personal computer. The \$15 subscription price includes all ten issues of volume 1; the first issue was available December 1. *The Rainbow* will include items of interest solely to Apple II owners. Send subscription orders, articles, letters, software (for review, exchange, or sale) to *The Rainbow*, P. O. Box 43, Audubon, PA 19407. BAC/VISA/MC/check/money orders accepted. Sorry, no C.O.D. or billing. For airmail service overseas, add \$10.

## GAMES CENTRE CATALOG

A complete catalog of games is available from this United Kingdom source. Almost 3000 games are arranged in these interesting sections: family games, abstract games, adult games, war games, fantasy & science fiction games, chess, traditional games, Oriental games, chance games and pub games, children's games, magic & conjuring, puzzles and jigsaws. A must for any recreation-oriented family. Ask for this catalog from: Games Centre, 16 Hanway Street, London W1A 2LS.

## COMMUNITY MEMORY PROJECT EXPANDS ITS SERVICES

Loving Grace Cybernetics (founders of the Community Memory Computerized Information Exchange) is alive and well and working in Berkeley.

There's a new address and a new name: The Community Memory Project, 1814 Ward St., Berkeley, CA 94703; (415) 841-1114.

The Community Memory Project will soon set up an expanded version of the information exchange, which will consist of a network of 10-20 public terminals. The community computer network is designed to provide an open channel for the sharing of information which is entered, indexed, and retrieved directly by the user.

According to CMP, "We believe that providing this means of communication

between people in different parts of a community will help people connect with others of similar interests and aid the exchange of goods, resources, and ideas. This communications network is non-hierarchical and interactive—that is, the information in the system is created and shared by the people who use it, not 'broadcast' from a central authority."

CMP recently formed an alliance with Village Design, a non-profit educational and scientific organization. Village Design will publish the *Journal of Community Communications* as a forum for exchanging notes and theories on community information systems. In addition, Village Design is doing a background study on communications among businesses and organizations in one neighborhood of San Francisco. It also sponsors a resource library and is planning a series of mini-conferences via computer on a time-sharing network.

For more information on the *Journal* and other projects, contact: Sandy Emerson, Coordinator, Village Design, P. O. Box 996, Berkeley, CA 94701.

## RENAISSANCE MAN CONFERENCE

The Association for Educational Data Systems (AEDS) will hold its 17th Annual Convention at the Detroit Plaza Hotel, in the heart of Detroit's Renaissance Center, May 15-18, 1979. The convention theme is "Renaissance Man—The Key Component."

The convention program will focus on computer applications, computer resources, computer related curriculum, application development methodologies, and futures. Presentations which emphasize mankind's adaptability to effectively utilize computer technology in the solution of human problems are especially solicited. Exhibits, user group meetings, and vendor sessions will be offered in addition to the program topics mentioned above.

AEDS-'79 will start with Affiliate and User Group meetings on Monday and Tuesday, with conference sessions scheduled Tuesday noon through Friday noon. Exhibits will be open Tuesday through Thursday from 9:00 A.M. to 5:00 P.M. Many special activities are planned for convention attendees, their

spouses and children. Contact: Arthur W. Daniels, Jr., Convention Coordinator, AEDS-'79, 31202 Dorchester, Madison Heights, MI 48071. Tel.: (313) 585-7530.

## INTERNATIONAL MASTER WRITES ABOUT COMPUTER CHESS

*Chess and Computers* by David Levy  
(Review from International Scholarly Book Services.)

A specialty book primarily of interest to computer programmers, systems analysts, mathematicians, and very serious chess players. Relatively technical in its presentation, the volume is nonetheless an excellent introduction to the world of computer chess. Levy covers early chess machines, the earliest chess-playing computer programs, the major chess tournaments in which computer programs have "played" and the most recent developments in computer chess. The author is the knowledgeable English international master who has offered a bet of \$5,000 that he can beat any computer program in existence. Though technical, the text is readable, and the games are annotated in a lively style. An extensive bibliography is provided. 145 pp. \$8.95. Available from ISBS, 2130 Pacific Ave., Forest Grove, OR 97116.

## FREE GUIDE TO HOME COMPUTERS

A helpful book on the latest and best information about home computing is offered *free* by NCE/CompuMart, Inc. *Getting Started with Microcomputers* evaluates 25 books and periodicals on current technology and equipment and recommends each for its usefulness to the programmer, engineer or systems designer.

This illustrated paperback also includes an up-to-date buyer's guide with current prices and capabilities of today's home computers. It explains what each computer can do for fun—games like baseball, aerial battles, blackjack, scramble and biorhythm analyses—and for household management services like balancing the checkbook and simple bookkeeping. Also details the expansion possibilities of each system. To receive your free copy, write: NCE/CompuMart, Inc., P. O. Box 8610, Ann Arbor, Michigan 48107. □

4 61 06 UN1 30 008  
UNIV MI CROFILM SERIA PROC  
300 N ZEEB RD  
ANN ARBOR, MI 48106  
3799



# Dr. Dobb's Journal

of Computer Calisthenics & Orthodontia



## FREE SOFTWARE

### COMPLETE SYSTEMS & APPLICATIONS SOFTWARE

For documentation, internal specifications, annotated source code. In the two years of publication, *DDJ* has carried a large variety of interpreters, editors, debuggers, monitors, graphics games software, floating point routines and software design articles.

## INDEPENDENT CONSUMER EVALUATIONS

### PRODUCT REVIEWS & CONSUMER COMMENTS

*Dr. Dobb's Journal* publishes independent evaluations—good or bad—of products being marketed to hobbyists. It is a subscriber-supported journal. *Dr. Dobb's* carries no paid advertising; it is responsible *only* to its readers. It regularly publishes joyful praise and raging complaints about vendors' products and services.

## REVIEWS

"A publication that is a must for everyone in the hobbyist world of computers. Don't miss it."

*'Newsletter'*  
*The Digital Group*

"THE software source for microcomputers. Highly recommended."

*'The Data Bus'*  
*Philadelphia Area Computer Society*

"It looks as if it's going to be THE forum of public domain hobbyist software development. Rating — ★ ★ ★ ★"

*'TRACE'*  
*Toronto Region Association of Computer Enthusiasts*

"The best source for Tiny BASIC and other good things. Should be on your shelf."

*'The Computer Hobbyist'*  
*North Texas (Dallas) Newsletter*

*Dr. Dobb's Journal* is published 10 times a year by People's Computer Company, a non-profit education corporation. For a one-year subscription, send \$15 to *Dr. Dobb's Journal*, Dept 5J, 1263 El Camino Real, Box E, Menlo Park, CA 94025 or send in the postage-free card at the center of this magazine.